

SEIKO



GPS
SOLAR



READ FIRST



CONTENTS

Complete User Guide

5X83 GPS Solar Watch (Dual Time Chronograph)

**Thank you very much for choosing a SEIKO watch.
For proper and safe use of your SEIKO watch,
please read carefully the instructions in this
booklet before using it.**

- * Length adjustment service for metallic bands is available at the retailer from whom the watch was purchased. If you cannot have your watch repaired by the retailer from whom the watch was purchased because you received the watch as a gift, or you moved to a distant place, please contact SEIKO CUSTOMER SERVICE CENTER. The service may also be available on a chargeable basis at other retailers, however, some retailers may not undertake the service.
- * If your watch has a protective film for preventing scratches, make sure to peel it off before using the watch. If the watch is used with the film on it, dirt, sweat, dust, or moisture may be attached to the film and may cause rust.

Handling cautions

WARNING

Please note that there is a risk of serious consequences such as severe injury if the following safety regulations are not strictly observed.

Immediately stop wearing the watch in following cases:

- If the watch body or band becomes edged by corrosion etc.
- If the pins protrude from the band.
 - * Immediately consult the retailer from whom the watch was purchased or SEIKO CUSTOMER SERVICE CENTER.

Keep the watch and accessories out of the reach of babies and children.

Care should be taken to prevent a baby or a child accidentally swallowing the accessories.
If a baby or child swallows the battery or accessories, immediately consult a doctor, as it will be harmful to the health of the baby or child.

Do not remove the secondary battery from the watch.

- * About the secondary battery → Power Source P. 47
Replacement of the secondary battery requires professional knowledge and skill. Please ask the retailer from whom the watch was purchased for replacement of the secondary battery.
Installation of an ordinary silver oxide battery can generate heat that can cause bursting and ignition.

CAUTION

Please note that there is a risk of minor injury or material damage if the following safety regulations are not strictly observed.

Avoid the following places for wearing or keeping the watch:

- Places where volatile agents (cosmetics such as polish remover, bug repellent, thinners etc.) are vaporizing
- Places where the temperature drops below 5°C or rises above 35°C for a long time (41°F and 95°F)
- Places affected by strong magnetism or static electricity
- Places affected by strong vibrations
- Places of high humidity
- Dusty places

If you observe any allergic symptoms or skin irritation

Stop wearing the watch immediately and consult a specialist such as a dermatologist or an allergist.

Other cautions

- For adjusting the length of the metallic band, specialized knowledge and expertise are necessary. Therefore, in such a case, contact the retailer from whom the watch was purchased. If you attempt to adjust the metallic band, injury may occur to your hand or fingers, or parts of the band may be lost.
- Do not disassemble or tamper with the watch.
- Please follow local government directions when disposing of the watch body and secondary battery.
- Keep the watch out of the reach of babies and children. Extra care should be taken to avoid risks of any injury or allergic rash or itching that may be caused when you touch the watch.
- If your watch is of the fob or pendant type, the strap or chain attached to the watch may damage your clothes, or injure the hand, neck, or other parts of your body.
- Please keep in mind that if a watch is taken off and placed down as it is, the case back, the band and the clasp will rub against each other possibly causing scratches on the case back. We recommend placing a soft cloth between the case back, the band and the clasp after taking off your watch.

⚠ WARNING



Do not use the watch for scuba diving or saturation diving.

The various tightened inspections under simulated harsh environment, which are usually required for watches designed for scuba diving or saturation diving, have not been conducted on the water resistant watch with the BAR (barometric pressure) display. For diving, use watches specifically designed for diving.

⚠ CAUTION



Do not pour running water directly from faucet.

The water pressure of tap water from a faucet is high enough to degrade the water resistant performance of a water resistant watch for everyday life.

⚠ CAUTION



Do not turn or pull out the crown when the watch is wet.

Water may get inside of the watch.

* If the inner surface of the glass is clouded with condensation or water droplets appear inside of the watch for a long time, the water resistant performance of the watch is deteriorated. Immediately consult the retailer from whom the watch was purchased or SEIKO CUSTOMER SERVICE CENTER.



Do not leave moisture, sweat and dirt on the watch for a long time.

Be aware of a risk that a water resistant watch may lessen its water resistant performance because of deterioration of the adhesive on the glass or gasket, or the development of rust on stainless steel.



Do not wear the watch while taking a bath or a sauna.

Steam, soap or some components of a hot spring may accelerate the deterioration of water resistant performance of the watch.

Features

■ This is a GPS solar watch.

* Unlike navigation equipment, this GPS solar watch is not designed to constantly receive GPS signals from GPS satellites without any operation. This watch receives GPS signals only in the time zone adjustment mode, automatic or manual time adjustment mode.

This watch has the following features.

GPS signal reception

This watch can be set to the precise local time by just one button operation anywhere in the world.

DST (Daylight Saving Time) is reflected in the time that appears.

This watch quickly adjusts the time by receiving GPS signals from GPS satellites.

- Place where GPS signals can be easily received/Place where GPS signals cannot be received [P. 18](#)

This watch responds to all the time zones around the world.

- Time zone [P. 6](#)

When the region or time zone where the watch is used is changed, please carry out operation of “time zone adjustment.”

- How to adjust the time zone [P. 22](#)

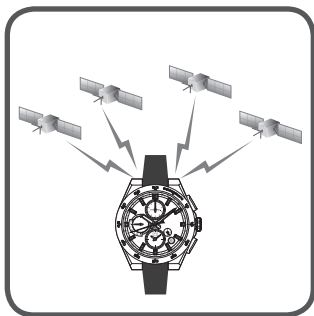

Solar charging Function

This watch operates by solar charging.

Expose the dial to light to charge the watch.

The watch will operate for about 6 months on a full charge.

When the energy stored in the watch runs out completely, it takes time to fully charge the watch, so please keep in mind to charge the watch regularly.

- How to charge the watch [P. 16](#)
- Standard Charging Time [P. 16](#)

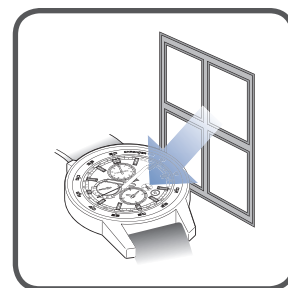

Automatic time adjustment function

This watch automatically adjusts the time in accordance with action patterns during use.

When the watch has sensed sufficient brightness under an open sky, it automatically receives GPS signals from GPS satellites. This function enables the watch to automatically adjust the time precisely even while you are using the watch.

- Automatic time adjustment [P. 31](#)

* This watch is unable to receive GPS signals when the energy stored in the watch is low.

- Check the charging status [P. 14](#)



Mechanism by which the GPS solar watch sets time and date

■ GPS satellite

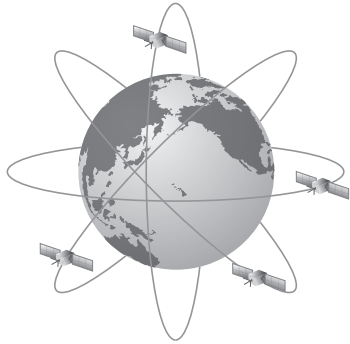

This is a satellite operated by the United States Department of Defense (official name is NAVSTAR), and orbits the earth at an altitude of 20,000 km.

Initially, this was a military satellite, but at present, information is partially disclosed to the public and used in various equipment including car navigation systems and cellular phones.

The GPS satellite is mounted with a high-accuracy atomic clock with an accuracy deviation of 1 second per 100,000 years.

■ Mechanism by which this watch sets the time and date

This watch receives GPS signals from GPS satellites to set the time and date based on the following information.

- Precise time and date based on the atomic clock
- Information about a time zone where you are and its adoption of DST (Daylight Saving Time)
(The current location is basically positioned by more than 4 GPS satellites, and which zone of the total of 38 time zones around the world you are in, and details regarding its adoption of DST (Daylight Saving Time), is identified.)

* To receive information about a time zone where you are, it is necessary to adjust the time zone.

→ How to adjust the time zone [P. 22](#)

* Unlike navigation equipment, this GPS solar watch is not designed to constantly receive GPS signals from GPS satellites without any operation.

This watch receives GPS signals only in the time zone adjustment mode, automatic or manual time adjustment mode.

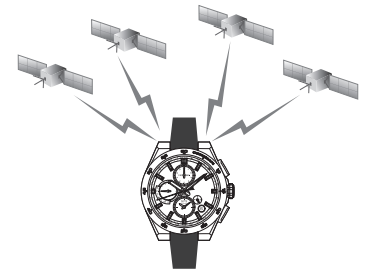

Time zone

■ Time zone

Based on Coordinated Universal Time (UTC), the standard time commonly used is adopted by countries and regions around the world.

Standard time is determined by nations and regions, with “time zone” used to refer to the whole of a region that uses the same standard time. At present, the globe is divided into 38 time zones (as of October, 2023).

■ DST (Daylight Saving Time)

Depending on the area, DST (Daylight Saving Time) is individually set.

Daylight Saving Time means summer time, which is a system to lengthen daylight time by advancing 1 hour when daylight time is long in summer.

The adoption and duration of daylight saving time vary depending on the country.

If the time zone adjustment is successful, data regarding the adoption of DST (Daylight Saving Time) for the country in which the GPS signals were received is reflected in the time that appears.

* DST (daylight saving time or “summer time”) in each region may be changed by countries and regions.

■ Coordinated Universal Time (UTC)

UTC is the universal standard time coordinated through an international agreement. This is used as the official time for recording time around the world. The time obtained by adding a leap second to the “International Atomic Time (TAI)” determined based on the atomic clock around the world and coordinated in order to compensate for deviations from universal time (UT) which is astronomically determined is the UTC.

The following functions are included

When the region or time zone where the watch is used is changed

Adjust the time zone.

The watch displays the precise local time where you are (which includes DST (Daylight Saving Time)).

- Time zone adjustment [P. 21](#)
- Time zone [P. 6](#)
- Time zone display and list of time zones around the world [P. 13](#)

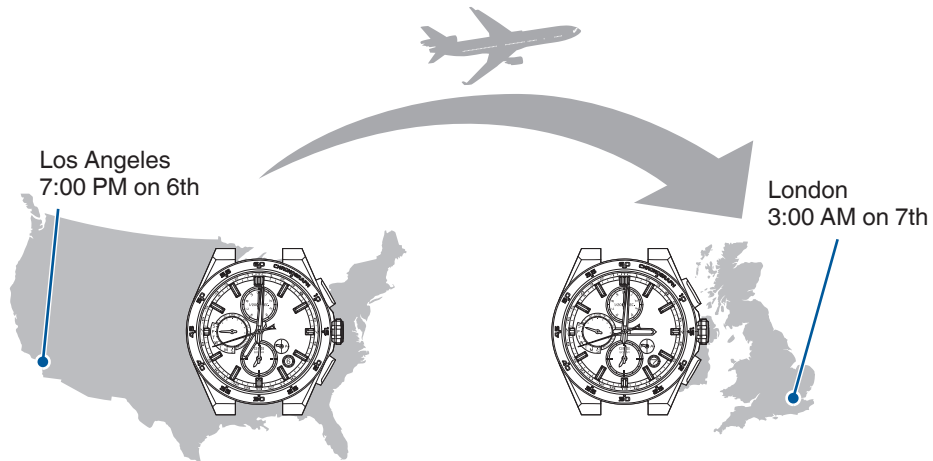

To set only the time

The watch displays the precise time of the time zone that is set by operation of “manual time adjustment.”

- How to manually adjust the time [P. 24](#)
- Check the time zone and DST (Daylight Saving Time) settings [P. 27](#)

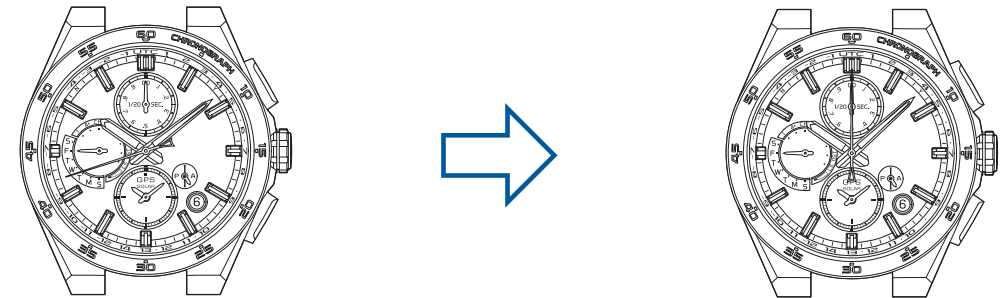

How to check when the time zone information was configured for your watch

The case back shows the caliber-case number of your watch.

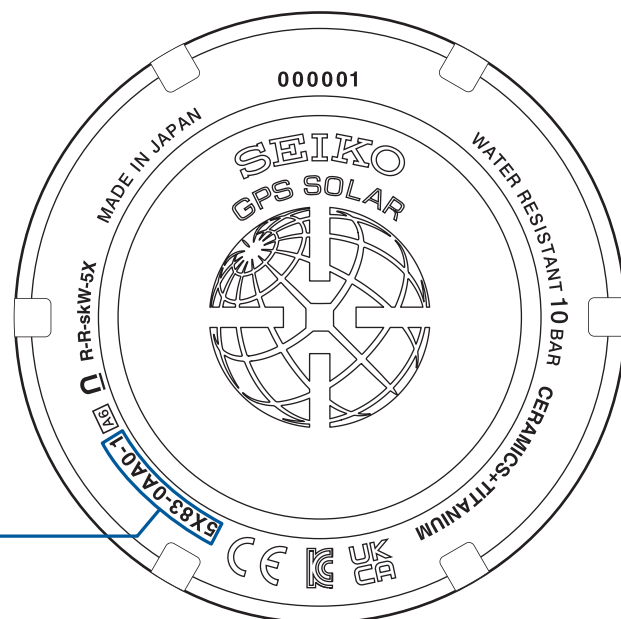

Caliber/case number
The number to identify the watch type

* Display may vary depending on the model.

By referring to caliber-case number shown on the case back, you will be able to determine when the time zone data was configured.

For more details, refer to the URL below.

<https://www.seikowatches.com/global-en/customerservice/knowledge/gpstimezonedatainfo>

If the official time zone, etc., has changed in a region after the watch's time zone data or DST (Daylight Saving Time) data was configured, the correct time will not be displayed even after receiving GPS signals. Please perform the following operations to display the correct time:

<To set the time of this watch in a region where the official time zone or DST (Daylight Saving Time) has changed>

1. Select the time zone appropriate for the current time in the target region by manual time zone setting and do settings for DST (Daylight Saving Time), as necessary.
For details, please refer to "Manual time zone setting" P. 25 and "Turn ON DST (Daylight Saving Time)" P. 26.
2. Next, adjust the time by manual time adjustment.
For details, please refer to "Manual time adjustment" P. 23.
3. When using the watch within the same time zone, the correct time will be displayed after automatic (GPS) or manual time adjustments.
4. When moving from a region where the official time zone has changed to a different time zone, then back to the region where the official time zone has changed, carry out the same operations from 1. - 3. as indicated above to display the correct time in the region where the official time zone has changed.

CONTENTS

1. READ FIRST	2	5. IN CASE OF AN UNUSUAL MOVEMENT OF THE SECONDS HAND	39
Handling cautions	2	Seconds hand movement and watch state (energy depletion forewarning function)	39
Features	4	6. TO PRESERVE THE QUALITY OF YOUR WATCH	40
Mechanism by which the GPS solar watch sets time and date	5	Daily care	40
Time zone	6	Performance and caliber / case number	40
The following functions are included	7	Water resistant performance	40
How to check when the time zone information was configured for your watch	8	Magnetic resistance	41
2. CONTENTS	9	Band	42
3. BEFORE USE	10	How to use an easy adjust type clasp	43
Names of the parts	10	How to use an adjustable three-fold clasp	44
Multi-function indicator hand display and reception result display	11	How to use an adjustable three-fold clasp (Pointed tip diving type)	45
Time zone display and list of time zones around the world	13	Lumibrite	46
Check the charging status	14	Power Source	47
About charging	16	After sales service	48
4. BASIC OPERATION (HOW TO SET THE TIME/HOW TO RECEIVE GPS SIGNALS, ETC.)	17	7. TROUBLESHOOTING	49
Basic operation flow	17	When the watch is unable to receive GPS signals	49
GPS signal reception	18	Adjust the time under a condition in which the watch is unable to receive GPS signals (Manual time setting)	49
To adjust the time zone and time by GPS signal reception (time zone adjustment)	21	When the sub-dial, stopwatch 1/20-second hand, multi-function indicator hand, date, or hour/minute/seconds hand position is misaligned	51
To adjust only the time by GPS signal reception (manual time adjustment)	23	Troubleshooting	56
To set the watch to the local time of the destination in an airplane, etc. (Manual time zone setting)	25	8. FUNCTION LIST/SPECIFICATIONS	61
Set DST (Daylight Saving Time)	26	Index	61
To adjust time on sub-dial	28	SPECIFICATIONS	62
Switching between the main-dial and sub-dial (Time Transfer Function)	30		
Automatic time adjustment	31		
When boarding (in-flight mode (✈))	32		
Leap second (Automatic leap second reception function)	33		
How to use the stopwatch	35		

Names of the parts

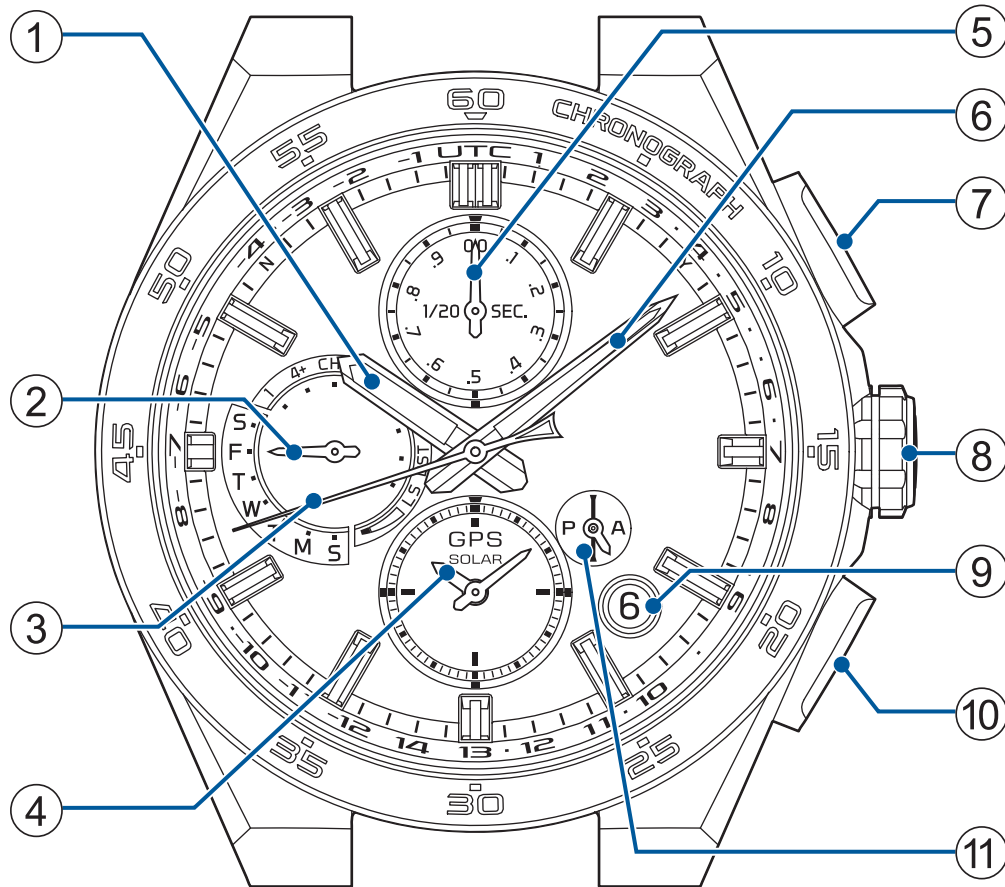

- ① Hour hand
- ② Multi-function indicator hand
(Usually displays the day of the week)
- ③ Seconds hand
(Stopwatch seconds hand)
- ④ Sub-dial (12-hour system)
(Stopwatch hour and minute hands)
- ⑤ Stopwatch 1/20-second hand
- ⑥ Minute hand
- ⑦ Button A
- ⑧ Crown
- ⑨ Date
- ⑩ Button B
- ⑪ Sub-dial AM/PM hand

* The orientation and design of the display may vary depending on the model.

Multi-function indicator hand display and reception result display

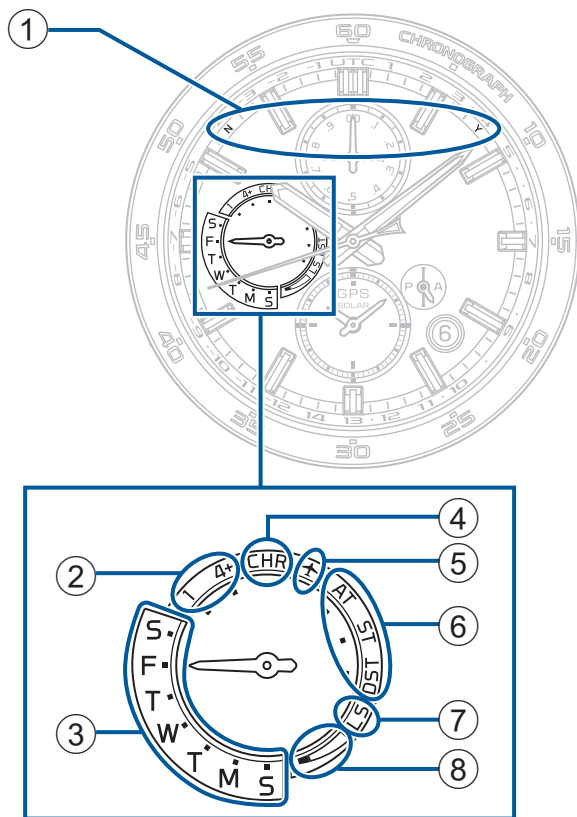

* The orientation and design of the display may vary depending on the model.

① Display of reception result (seconds hand)

Y : Reception successful (8-second position)

N : Reception failed (52-second position)

→ Check the reception result [P. 20](#)

② Display of receiving process

Receiving process	1 (time adjustment)	4+ (time zone adjustment)
Display		

→ Check the reception result [P. 20](#)

→ Time zone adjustment [P. 21](#)

→ Manual time adjustment [P. 23](#)

→ Automatic time adjustment [P. 31](#)

③ Display of day of the week

Hand position	Displays Sunday through Saturday (Illustration displays the Friday position)
Display	

④ Display of stopwatch mode

Hand position	Stopwatch (CHR) status
Display	

→ Stopwatch [P. 35](#)

⑤ Display of in-flight mode (✈)

Hand position	In-flight mode (✈) status
Display	

→ In-flight mode [P. 32](#)

⑥ Display of DST (Daylight Saving Time)

Hand position	AT (automatic)	ST (OFF)	DST (ON)
Display			

→ Check the time zone and DST (Daylight Saving Time) settings [P. 27](#)

→ Set DST (Daylight Saving Time) [P. 26](#)

⑦ Display of leap second data receipt

Hand position	Receiving leap second data
Display	

→ Receiving leap second data [P. 33](#)

⑧ Display of charging status

* The energy level is displayed in four levels.

Hand position	Full	Middle (two levels)		Low
Display				

→ Check the charging status [P. 14](#)

→ How to charge the watch [P. 16](#)

Time zone display and list of time zones around the world

The following list shows the relationship between displays of the bezel and dial ring and time difference from the UTC.

Please refer to the seconds hand positions below to set the time zone or to check the time zone setting.

DST (Daylight Saving Time) has been adopted in countries marked with a ★.

In the Lord Howe Island time zone in Australia with a ☆ mark, the time is advanced by 30 minutes while DST (Daylight Saving Time) is in effect. This watch corresponds to DST in the Lord Howe Island time zone.

Display of time zone or time difference

Representative city names...

28 cities among the total of 38 time zones around the world

Time difference...

+14 hours ~ -12 hours

→ Check the time zone and DST (Daylight Saving Time) settings P. 27

→ Time zone adjustment P. 21

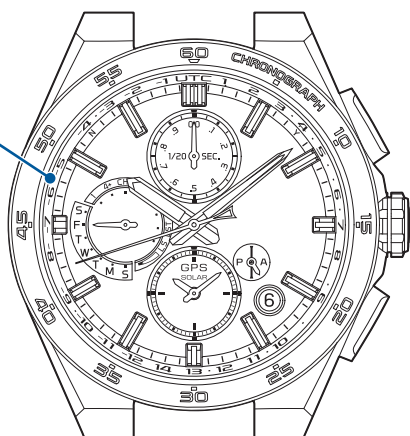

* The displays of city code and the time difference from UTC are Subject to change depending on model.

* “•” in the display shows that there is a time zone in that place.

City code	Display of time difference	City name	UTC ± hours
LON	UTC	★London	0
PAR	1	★Paris/ ★Berlin	+1
CAI	2	★Cairo	+2
JED	3	Jeddah	+3
•	•	Tehran	+3.5
DXB	4	Dubai	+4
•	•	Kabul	+4.5
KHI	5	Karachi	+5
DEL	•	Delhi	+5.5
•	•	Kathmandu	+5.75
DAC	6	Dhaka	+6
•	•	Yangon	+6.5
BKK	7	Bangkok	+7
BJS	8	Beijing	+8
•	•	Eucla	+8.75
TYO	9	Tokyo	+9
ADL	•	★Adelaide	+9.5
SYD	10	★Sydney	+10
•	•	☆Lord Howe Island	+10.5

City code	Display of time difference	City name	UTC ± hours
NOU	11	Nouméa	+11
WLG	12	★Wellington	+12
•	•	★Chatham Islands	+12.75
TBU	13	Nuku'alofa	+13
CXI	14	Kiritimati	+14
•	-12	Baker Island	-12
MDY	-11	Midway islands	-11
HNL	-10	Honolulu	-10
•	•	Marquesas Islands	-9.5
ANC	-9	★Anchorage	-9
LAX	-8	★Los Angeles	-8
DEN	-7	★Denver	-7
CHI	-6	★Chicago	-6
NYC	-5	★New York	-5
SDQ	-4	Santo Domingo	-4
•	•	★St. John's	-3.5
RIO	-3	Rio de Janeiro	-3
FEN	-2	Fernando de Noronha	-2
PDL	-1	★Azores	-1

* The time zone and adoption of DST (Daylight Saving Time) for each region are current as of October, 2023.

Check the charging status

The multi-function indicator hand position shows whether this watch is able or unable to receive GPS signals.

In addition, for the low charging state, the movement of the seconds hand shows the energy depletion state in further detail.

* GPS signal reception requires a lot of energy. Keep in mind to regularly charge the watch by exposure to light. → About charging P. 16

○ Reception is allowed

When the multi-function indicator hand continues to display the day of the week, the watch can receive signals.

The following operation allows you to check the energy level.

1 Press Button B and then release it

The display switches from the day of the week display to the energy level display. (5 seconds)

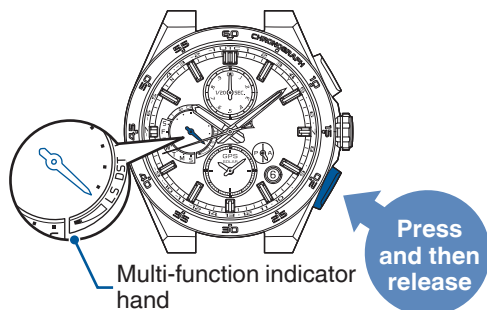

* The multi-function indicator hand continues to display “CHR” while switched to the stopwatch mode. To check the energy level, turn off the stopwatch mode. → P. 36

2 Check the charging status

* The energy level is displayed in four levels. → Display of charging status P. 12

Multi-function indicator display	Charging status	Solution
	full	Reception is allowed. Use the watch as it is. → P. 17
	middle	Reception is allowed, but keep in mind to charge the watch. → P. 17

* After 5 seconds have elapsed or when Button B is pressed, the watch returns to the time display mode.

✗ Reception is not allowed

When the energy level is low, the day of the week is not displayed, and the charging status display continuously recommends charging the watch.

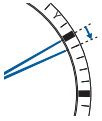
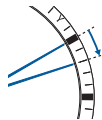
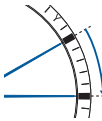
Multi-function indicator display	Movement of seconds hand	Charging status		Solution
	1-second interval movement 	low	The watch is unable to receive GPS signals, but has energy to operate.	Charge the watch until the multi-function indicator hand returns to the day of the week display so that the watch is able to receive GPS signals. When the hand returns to the day of the week display, the energy level will be "middle" or "full." → About charging P. 16
	2-second interval movement 	-	The watch is unable to receive GPS signals, and does not have energy to operate. (The energy depletion forewarning function is activated. → P. 39)	Continue to charge the watch until the multi-function indicator hand returns to the day of the week display so that the watch is able to continuously operate and receive GPS signals. → About charging P. 16
	5-second interval movement 	-		

* Press Button B during the charging status display to check the day of the week display. (5 seconds)

If the device is in in-flight mode (✗), reception is not possible regardless of the energy level.

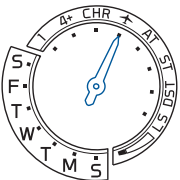
Multi-function indicator display	Movement of seconds hand	Charging status		Solution
	-	The charging status is not displayed for the in-flight mode (✗).		Reset the in-flight mode (✗). → Reset the in-flight mode (✗). P. 32 When the multi-function indicator hand points to "low," charge the watch. → About charging P. 16

About charging

How to charge the watch

Expose the dial to light to charge the watch.

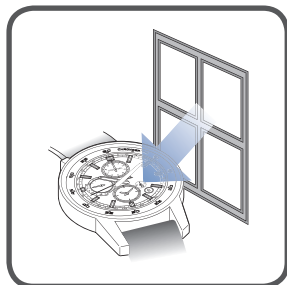

To ensure optimal performance of the watch, make sure that the watch is kept sufficiently charged at all times.

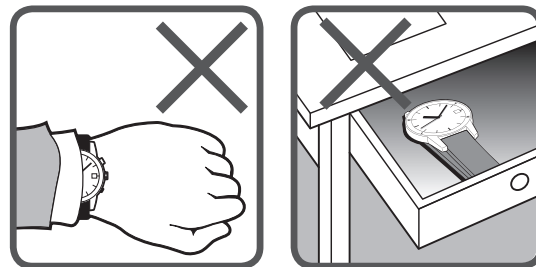

Under the following situations, the energy of the watch is likely to be depleted, resulting in stoppage of the watch:

- The watch is concealed under a sleeve.
- The watch is used or stored under conditions where it cannot be exposed to light for a long time.

* When charging the watch, make sure that the watch is not heated to a high temperature. (The operational temperature range is between -10°C to +60°C (14 °F and 140 °F).)

* When first using the watch or starting to use the watch after it has stopped because of the energy depletion, sufficiently charge the watch referring to the table on the page at the right.

Standard Charging Time

Charge the watch using the times below as a guide.

GPS signal reception consumes considerable energy. It is necessary to charge the watch by exposing it to light so that the multi-function indicator hand can continuously display the day of the week (the energy level will be “middle” or “full”). (If the charging status is displayed as “low,” the reception will not start even with manual GPS signal reception.)

→ Check the charging status [P. 14](#)

Illumination lx (LUX)	Light source	Condition (Example)	From the state where the watch is stopped (not charged)		In the state where the hand moves (the watch is charged)
			To fully charged	To one-second interval movement is secured	To move for one day
700	Fluorescent light	General offices	-	-	3.5 hours
3,000	Fluorescent light	30 W 20 cm	250 hours	9.5 hours	1 hour
10,000	Sunlight Fluorescent light	Cloudy day 30 W 5 cm	75 hours	3 hours	15 minutes
100,000	Sunlight	Sunny day (Under the direct sunlight on a summer day)	30 hours	1.5 hours	10 minutes

The figures of “Time required for charging the watch to start moving at one-second intervals” are estimations of time required to charge the stopped watch by exposing it to light until it moves at steady one-second intervals. Even if the watch is partially charged for a shorter period, the watch will resume one-second- interval movement. However, it may shortly return to two-second-interval movement. Use the charging time in this column as a rough guide for sufficient charging time.

* The required charging time slightly varies depending on the model.

Basic operation flow

1. Check the place where GPS signals can be easily received

→ Place where GPS signals can be easily received/Place where GPS signals cannot be received [P. 18](#)

Place where GPS signals can be easily received

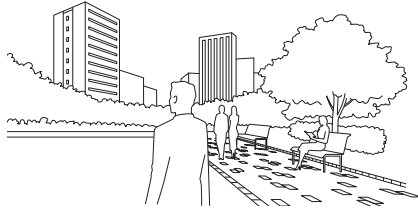

Outdoors under an open sky with good visibility

- When the region or time zone where the watch is used is changed
- To set only the time

2. Set the time zone and set the time and date

< Setting by GPS signal reception >

Receive GPS signals, set the time zone and set the time and date

→ How to adjust the time zone [P. 22](#)

* The time includes DST (Daylight Saving Time) due to the time zone adjustment.

Set only the time

→ How to manually adjust the time [P. 24](#)

< Manual setting >

→ Check the time zone and DST (Daylight Saving Time) settings [P. 27](#)

Time zone setting is not correct

→ How to manually set the time zone [P. 25](#)

Time zone setting is correct

→ How to manually set the time [P. 50](#)

Place where GPS signals cannot be received

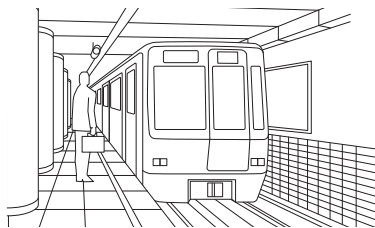

Example: Within a subway station

GPS signal reception

Place where GPS signals can be easily received/Place where GPS signals cannot be received

○ Easy to receive

- Outdoors under an open sky with good visibility

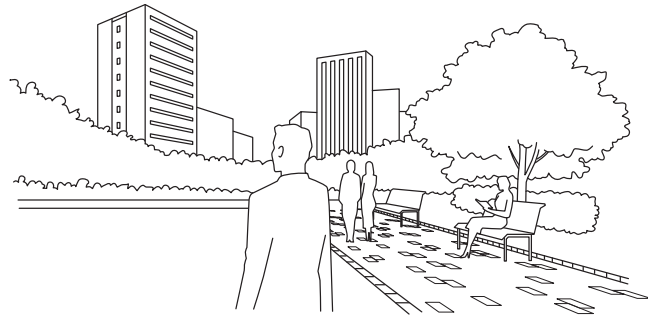

△ Difficult to receive

- The smaller the sky, the more difficult it is to receive GPS signals. In addition, it will also be difficult to receive GPS signals, if there is something that obstructs the GPS signals during reception (in particular, during time zone adjustment).

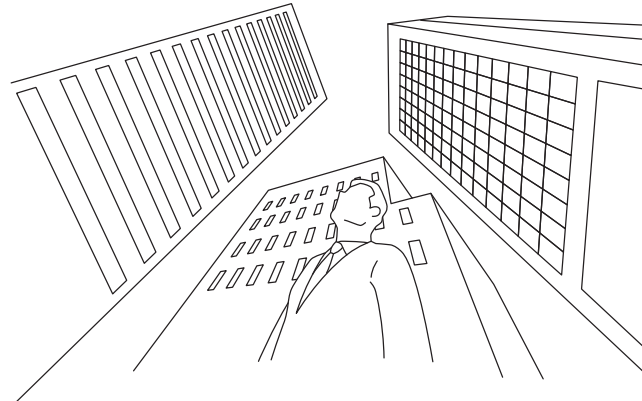

Examples:

- Between tall buildings
- Near wooded area
- Station/Airport
- Indoors with windows

* GPS signals cannot be received depending on window glass type.
Refer to the “✕ Cannot receive.”

✕ Cannot receive

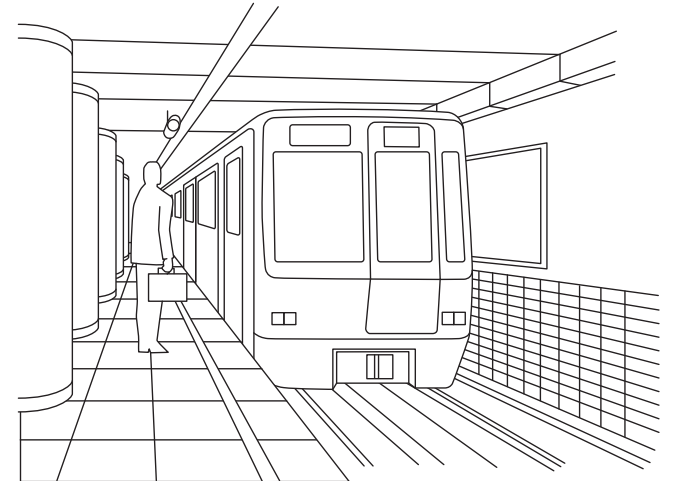

- The sky cannot be seen or only part of the sky can be seen.
- There is something hindering the reception.



Examples:

- Indoors without windows
- Underground
- During passage of a tunnel
- Through special glass with thermal emission shield effect, etc.
- Close to equipment generating noise or performing wireless communications

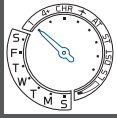
□ List of GPS signal reception methods (characteristics of all three types)

Reception method	Time adjustment		Time zone adjustment		Leap second data reception
Display		How to manually adjust the time → P. 23 Automatic time adjustment → P. 31		How to adjust the time zone → P. 21	
Features	Time adjustment Precise current time of the set time zone is displayed		Time zone identification and time adjustment <u>Time zone where you are is identified, and the precise current time, reflecting the addition conditions of DST (Daylight Saving Time), is displayed</u>		Leap second reception Ready for leap second data reception and receiving Leap second data → P. 33
Number of acquired satellites necessary for reception	One unit (to obtain only time information)		Basically more than 4 units (to obtain time information and time zone information)		-
Time taken for reception	3 seconds to 1 minute		30 seconds to 2 minutes		30 seconds to 18 minutes
What kind of situation	To set the watch to the precise time while it is used in the same time zone		When the watch is used in a different time zone		This is performed automatically after GPS signal reception (automatic time adjustment, manual time adjustment, or time zone adjustment) on or after June 1st and December 1st.

□ GPS signal reception Q & A

Q : When the watch is moved to a different time zone, does the watch automatically display the local time?

A : The watch does not automatically display the local time just by changing location. If you are in a place where GPS signals can be easily received, adjust the time zone. The watch automatically displays the local time. When you are in a place where GPS signals cannot be received, manually set the time zone.
→ Manual time zone setting P. 25
The watch can be set to all time zones around the world.

Q : Is DST (Daylight Saving Time) automatically changed by receiving GPS signals?

A : The settings for DST (Daylight Saving Time) are done automatically by doing a time zone adjustment. The time automatically switches to adjust for the adoption and duration of DST (Daylight Saving Time) for regions that follow DST (Daylight Saving Time). “Normal time” always appears for regions that do not adopt DST (Daylight Saving Time). Manually switch the DST (Daylight Saving Time) setting if you have moved to a place that adopts different DST (Daylight Saving Time) details, even if the area is the same time zone.
→ Set DST (Daylight Saving Time) P. 26
Even in the same time zone, some countries and regions do not adopt DST (Daylight Saving Time).
→ Time zone display and list of time zones around the world P. 13

Q : Is it necessary to carry out special operation for years in which a leap second is added?

A : No special operation is necessary. Since the watch receives leap second data at the same time of receiving GPS signals (automatic time adjustment, manual time adjustment, or time zone adjustment) on or after June 1st and December 1st, a leap second is automatically added by periodically receiving GPS signals. For details, refer to “Leap second (Automatic leap second reception function)” P. 33.

■ Check that reception was successful (reception result display)

The type of reception and reception result (success or failure) of the last GPS signal reception is displayed for 5 seconds.

- * If the watch is in stopwatch mode, turn off stopwatch mode.
→ Turning off stopwatch mode P. 36

1 Press Button A once and then release it

The seconds hand and multi-function indicator hand display the reception result.



- * When Button A is kept pressed, the watch enters the Manual time adjustment operation.

2 The result of the reception is displayed

The seconds hand displays the result of the GPS signal reception (time adjustment or time zone adjustment).
The multi-function indicator hand points to "1" or "4+" which shows "time adjustment" or "time zone adjustment."

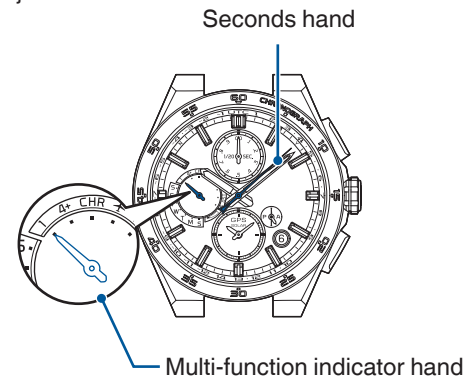

Seconds hand: Reception result (success/failure)

Result	Successful	Failed
Display		
Position	Y: 8-second position	N: 52-second position

Multi-function indicator hand:
Reception method (time adjustment or time zone adjustment)

Type	1 (Time adjustment)	4+ (Time zone adjustment)
Display		

- * The indicator hand points to "4+" as a result of time zone adjustment.
* After 5 seconds have elapsed or when Button B is pressed, the watch returns to the time display mode.

When the reception result is Y

- The reception was successful.
Use the watch as it is.

When the reception result is N

- Move to the outdoors where GPS signals can be easily received as necessary to receive GPS signals.

→ Place where GPS signals can be easily received/Place where GPS signals cannot be received P. 18

- When approximately four days have elapsed after successful reception, the reception result display becomes "N".
- Even under a state where GPS signal cannot be received, the watch operates with quartz accuracy (at loss/gain ± 15 seconds per month).

When the reception has failed in any way, manually set the time and date.

→ How to manually set the time P. 50

To adjust the time zone and time by GPS signal reception (time zone adjustment)

□ Time zone adjustment

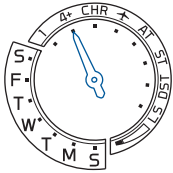

The time zone where you are is localized to adjust the watch to the precise current time by just one button operation anywhere in the world.

This reflects the data regarding the adoption of DST (Daylight Saving Time) in the country that received the GPS signals.

The time automatically switches to adjust for the adoption and duration of DST (Daylight Saving Time) for countries that follow DST (Daylight Saving Time).

“Normal time” always appears for countries that do not adopt DST (Daylight Saving Time).

→ How to adjust the time zone [P. 22](#)

* Failure or success of reception depends on the reception environment. → Place where GPS signals can be easily received/Place where GPS signals cannot be received [P. 18](#)

* GPS signal reception consumes considerable energy.

It is necessary to charge the watch by exposing it to light so that the multi-function indicator hand can continuously display the day of the week (the energy level will be “middle” or “full”). → How to charge the watch [P. 16](#)

(If the energy level is “low,” reception will not begin even if GPS signal reception is operated.)

→ Check the charging status [P. 14](#)

Precautions on time zone adjustment

If the time zone is adjusted near a time zone boundary, the time of the adjacent time zone may be displayed.

In some areas the boundaries observed by the watch may not exactly correlate to the actual time zone markers on the land. This does not indicate a malfunction.

In this case, set the time zone in the manual time zone setting mode.

→ How to manually set the time zone [P. 25](#)

When the time zone is adjusted while traveling on land, avoid time zone boundaries to carry out time zone adjustment in the representative cities in the time zone whenever possible.

In addition, when the watch is used near time zone boundaries, make sure to check the time zone setting, and manually set the time zone as necessary.

How to adjust the time zone

1 Go to a place where GPS signals can be easily received

Move to the outdoors under an open sky with good visibility.

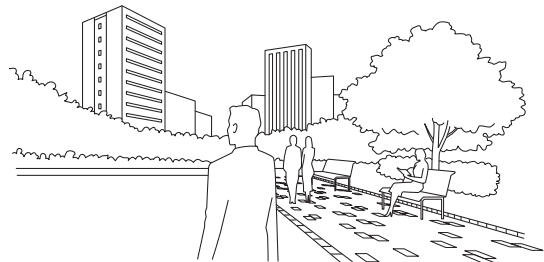

→ Place where GPS signals can be easily received/
Place where GPS signals cannot be received P. 18

2 Continue to press Button B (3 seconds), and then release it when the seconds hand moves to the 30-second position

When the seconds hand has reached the 30-second position, reception is started.

The multi-function indicator hand points to "4+".

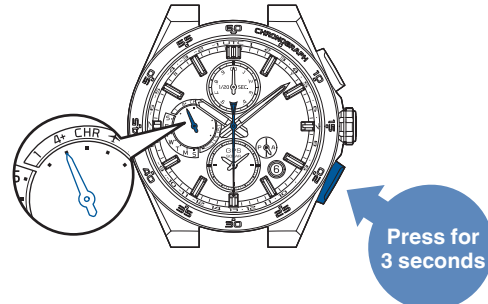

- * While the multi-function indicator hand points to "low," ✂ or "CHR", reception is not started even with operation for reception.
- * When the hand points to "low," charge the watch by exposure to light.
→ Check the charging status P. 14
→ How to charge the watch P. 16
- * When the hand points to ✂, reset the in-flight mode (✂).
→ Reset the in-flight mode (✂). P. 32
- * When the hand points to "CHR", turn off the stopwatch mode
→ Turning off stopwatch mode P. 36

3 Direct the watch face upward and wait

* Please note that it may be difficult to receive GPS signals while you are in motion.

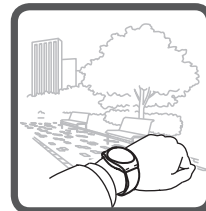

It takes a maximum of 2 minutes to complete reception.
* It depends on the receiving conditions.

< Display during reception (= satellites acquisition status) >

The seconds hand indicates ease of receiving (= number of GPS satellites from which GPS signals are received).

- * The larger the number of acquired satellites there are, the easier it is to receive GPS signals.

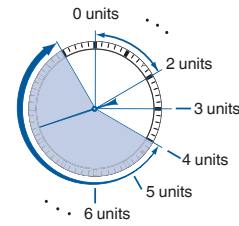

Number of satellites	Ease of reception
4 units or more	Easy to receive
3 units	May receive
0-2 units	Cannot receive

- * Even when the hand points to 4 units or more, reception may not be allowed.

- * To cancel the reception, press Button B.

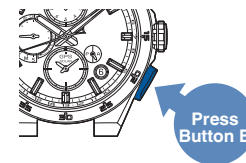

4 When the seconds hand points to "Y" or "N", reception is completed

The reception result is displayed for 5 seconds.

If reception is successful, the time and date are adjusted.

The settings for the time zone and DST (Daylight Saving Time) are reflected in the time that appears.

Reception result display	Y: Successful (8-second position)	N: Failed (52-second position)
Display		
State	Use the watch as it is.	When the reception result is displayed as "N" → P. 18

Check that the reception is successful after the watch returns to the time display mode.

→ Check that reception was successful (reception result display) P. 20

- * The buttons cannot be operated while the hour and minute hands, multi-function indicator hand, or sub-dial is moving.

To adjust only the time by GPS signal reception (manual time adjustment)

Manual time adjustment



The watch can be set to the precise current time of the currently set time zone.
(The time zone is not changed.)

- How to manually adjust the time [P. 24](#)
- Check the time zone and DST (Daylight Saving Time) settings [P. 27](#)

* In the manual time adjustment, the precise time of the currently set time zone is displayed.

When the region or time zone where the watch is used is changed, adjust the time zone. → How to adjust the time zone [P. 22](#)

(If the time zone is adjusted, the time zone setting, time and date will be adjusted, so it is not necessary to manually adjust the time immediately thereafter.)

* Except when time zone adjustment (reception) is successful and DST = "AT," DST (daylight saving time or "summer time") is not set automatically. Please perform the setting manually. → Set DST (Daylight Saving Time) [P. 26](#)

* Failure or success of reception depends on the reception environment. → Place where GPS signals can be easily received/Place where GPS signals cannot be received [P. 18](#)

* At the time when the reception was successful by manually adjusting the time, automatic time adjustment may be performed. For details, refer to "Automatic time adjustment" [P. 31](#).

* GPS signal reception consumes considerable energy.

It is necessary to charge the watch by exposing it to light so that the multi-function indicator hand can continuously display the day of the week (the energy level will be "middle" or "full"). → How to charge the watch [P. 16](#)

(If the energy level is "low," reception will not begin even if GPS signal reception is operated.)

→ Check the charging status [P. 14](#)

How to manually adjust the time

1 Go to a place where GPS signals can be easily received

Move to the outdoors under an open sky with good visibility.

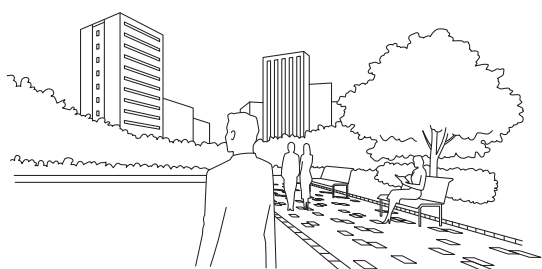

→ Place where GPS signals can be easily received/
Place where GPS signals cannot be received P. 18

2 Continue to press Button A (3 seconds), and then release it when the seconds hand moves to the 0-second position

When the seconds hand has reached the 0-second position, reception is started.

The multi-function indicator hand points to "1".

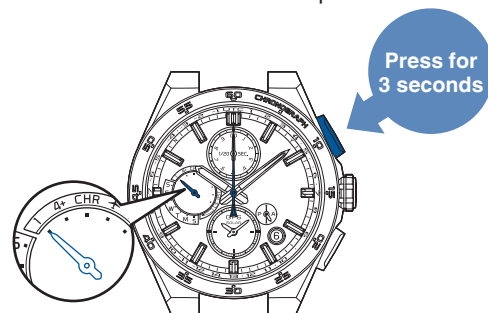

- * While the multi-function indicator hand points to "low," ✂ or "CHR", reception is not started even with operation for reception.
- * When the hand points to "low," charge the watch by exposure to light.
 - Check the charging status P. 14
 - How to charge the watch P. 16
- * When the hand points to ✂, reset the in-flight mode (✂).
 - Reset the in-flight mode (✂). P. 32
- * When the hand points to "CHR", turn off the stopwatch mode
 - Turning off stopwatch mode P. 36

3 Direct the watch face upward and wait



It takes up to one minute to complete reception.
* The reception time depends on the reception conditions.

< Display during reception (= satellites acquisition status) >

The seconds hand indicates ease of receiving (= number of GPS satellites from which GPS signals are received).

* To acquire only time information, the number of satellites necessary for reception is one.

Number of acquired satellites	1	0
Display		
State	Easy to receive	Cannot receive

* To cancel the reception, press Button B.

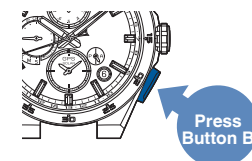

4 When the seconds hand points to "Y" or "N", reception is completed

The reception result is displayed for 5 seconds.

If reception is successful, the time, date, and day are adjusted.

Reception result display	Y: Successful (8-second position)	N: Failed (52-second position)
Display		
State	Use the watch as it is.	When the reception result is displayed as "N" → P. 18

Check that the reception is successful after the watch returns to the time display mode.

→ Check that reception was successful (reception result display) P. 20

When the time is not correct even if "Y" is displayed, the time zone may not correspond to the region where you are. Check the time zone setting.

→ Check the time zone and DST (Daylight Saving Time) settings P. 27

* The buttons cannot be operated while the hour and minute hands, multi-function indicator hand, or sub-dial is moving.

To set the watch to the local time of the destination in an airplane, etc. (Manual time zone setting)

Manual time zone setting

→ Manual time zone setting of the sub-dial P. 28

In places where the time zone cannot be adjusted, the time zone can be set manually.

→ Place where GPS signals can be easily received/Place where GPS signals cannot be received P. 18

Set the time zone with reference to the “Time zone display and list of time zones around the world” P. 13 to set the watch to the local time and date.

* Note that by doing manual time zone setting, the DST (Daylight Saving Time) state switches from “AT (automatic)” to the “ST (OFF)” or “DST (ON).”

Set DST (Daylight Saving Time) for the main-dial with reference to “Turn ON DST (Daylight Saving Time)” P. 26.

How to manually set the time zone

1 Pull out the crown to the first click

The seconds hand moves to display the currently set time zone.

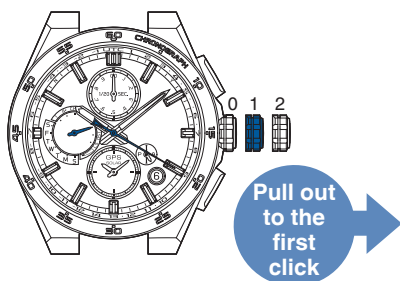

2 Turn the crown and set the seconds hand to the time zone of the destination

When the crown is turned, the seconds hand moves to the next zone.

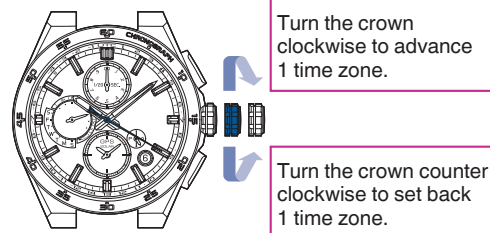

<Multi-function indicator hand display>

Displays ON/OFF setting of DST (Daylight Saving Time).

Hand position	AT (automatic)	ST (OFF)	DST (ON)
Display			

* When you have selected a new time zone, even if it was “AT (automatic)” before the time zone selection, it switches to “DST (ON)” or “ST (OFF).”

* If DST (Daylight Saving Time) is not correct, change over ON/OFF with reference to “Turn ON DST (Daylight Saving Time)” P. 26 after operation of **2**.

3 Push the crown back in

The seconds hand returns to the time display mode.

The multi-function indicator hand returns to display the day of the week.

* If the energy level is low, the day of the week is not displayed, and the watch returns to a charging status display of “low.”

* The buttons cannot be operated while the hour and minute hands, multi-function indicator hand, or sub-dial is moving.

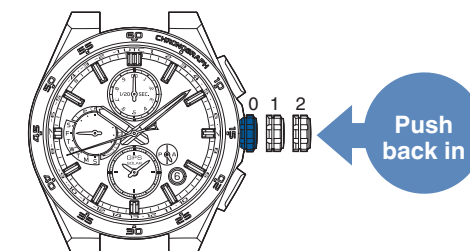

Set DST (Daylight Saving Time)

Turn ON DST (Daylight Saving Time)

DST (Daylight Saving Time) can be manually set.

Be sure to do the settings in the following situations.

- When the main-dial is adjusted using the manual time zone setting and DST (Daylight Saving Time) is implemented.
- When the time zone is the same, but the settings for DST (Daylight Saving Time) differ according to the area to which you move.

→ Set the DST (Daylight Saving Time) of the sub-dial. [P. 29](#)

* The indicator's DST (Daylight Saving Time) is not changed to "AT (automatic)" if you have done the manual time zone setting.

Turn DST (Daylight Saving Time) manually on or off, according to whether DST (Daylight Saving Time) is implemented or not.

1 Pull out the crown to the first click

The multi-function indicator hand moves to indicate the current DST (Daylight Saving Time) setting. The seconds hand displays the current time zone.

< When DST (Daylight Saving Time) setting is OFF >

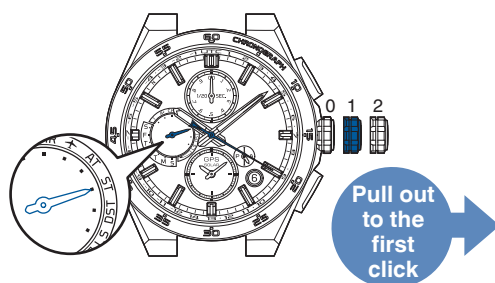

2 Continue to press Button A (3 seconds)

The multi-function indicator hand moves to point to "DST", and the hour and minute hands advance by one hour.

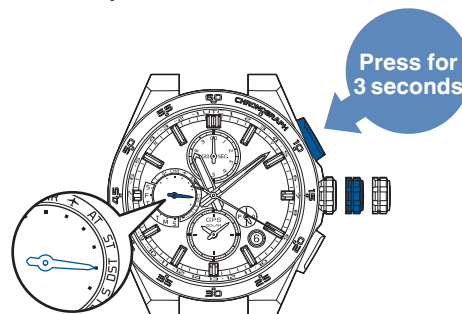

* In the Lord Howe Island time zone in Australia, the time is advanced by 30 minutes while DST (Daylight Saving Time) is in effect. This watch corresponds to DST in Lord Howe Island time zone.

3 Push the crown back in

The seconds hand returns to the time display mode.

The multi-function indicator hand returns to display the day of the week.

* If the energy level is low, the day of the week is not displayed, and the watch returns to a charging status display of "low."

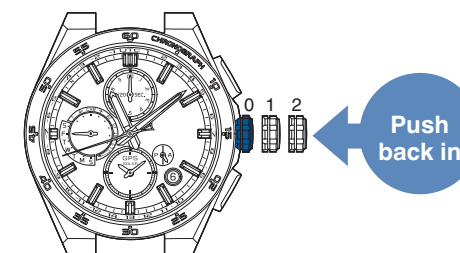

Turn OFF DST (Daylight Saving Time)

Carry out operation of **1** to **3** in the state where DST (Daylight Saving Time) setting is ON.

In operation of **2**, adjust the multi-function indicator hand to the "ST (OFF)" position as shown in the figure at the right.

The hour and minute hands return by one hour.

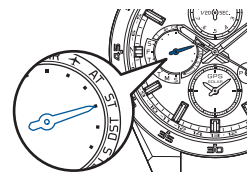

■ Check the time zone and DST (Daylight Saving Time) settings

The timezone and DST (Daylight Saving Time) can be checked for each of the main-dial and sub-dial.

1 Pull out the crown to the first click

The seconds hand moves to display the currently set time zone.
The multi-function indicator hand indicates DST (Daylight Saving Time) setting.

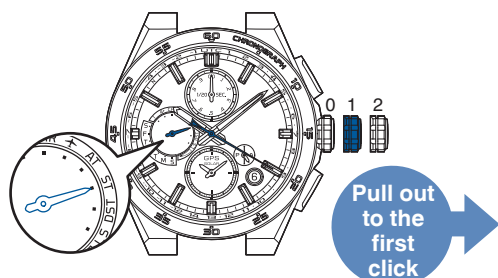

<Multi-function indicator hand display>
Displays the status for DST (Daylight Saving Time).

Hand position	AT (automatic)	ST (OFF)	DST (ON)
Display			

AT (automatic):
"AUTO (automatic)" is set when your watch successfully adjusts the time zone in a region that has adopted DST (Daylight Saving Time).
The basic time automatically changes due to your watch adapting to the implementation of DST (Daylight Saving Time) for the time zone (region) set for the main-dial.

- * To change the time zone setting
- When you are in a place where GPS signals can be easily received
How to adjust the time zone P. 22
- When you are in a place where GPS signals cannot be received
How to manually set the time zone P. 25

* For the relationship between the seconds hand position and time zone, refer to the "Time zone display and list of time zones around the world" P. 13

2 Pull out the crown to the second click

The seconds hand moves to display the currently set time zone of the sub-dial. The multi-function indicator hand displays the DST (Daylight Saving Time) setting of the sub-dial.

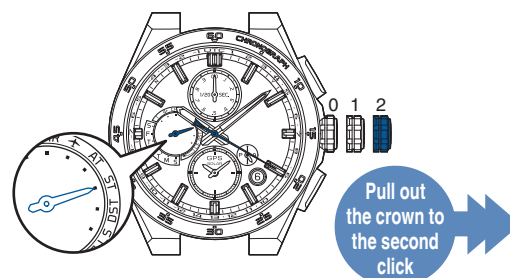

<Multi-function indicator hand display>
Displays the status for DST (Daylight Saving Time).

Hand position	AT (automatic)	ST (OFF)	DST (ON)
Display			

AT (automatic):
"AUTO (automatic)" is set when the main dial and sub-dial are switched after your watch successfully adjusts the time zone in a region that has adopted DST (Daylight Saving Time).
The sub-dial automatically changes due to your watch adapting to the implementation of DST (Daylight Saving Time) for the time zone (region) set for the sub-dial.

- * Changing the time zone settings for the sub-dial
How to manually set the time zone of the sub-dial P. 28
- * For the relationship between the seconds hand position and time zone, refer to the "Time zone display and list of time zones around the world" P. 13

3 Push the crown back in

The seconds hand returns to the time display mode.
The multi-function indicator hand returns to display the day of the week.

* If the energy level is low, the day of the week is not displayed, and the watch returns to a charging status display of "low."

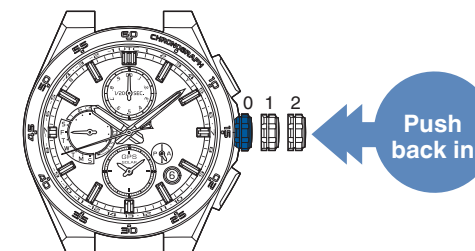

To adjust time on sub-dial

Manual time zone setting of the sub-dial

The sub-dial can be set to a time zone of your choice.

Adjust the sub-dial by selecting the time of the time zone.

* The sub-dial cannot be adjusted to a time outside the time zone.

How to manually set the time zone of the sub-dial

1 Pull out the crown to the second click

The seconds hand moves to display the sub-dial of the currently set time zone.

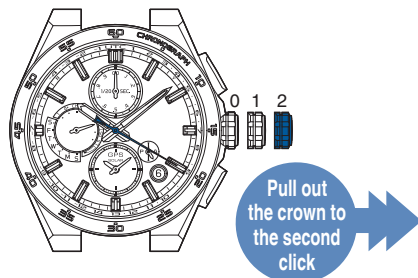

2 Turn the crown and set the seconds hand to the time zone of the destination

When the crown is turned, the seconds hand moves to the next zone.

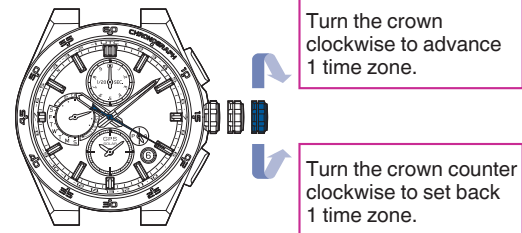

<Multi-function indicator hand display>

Displays ON/OFF setting of DST (Daylight Saving Time).

Hand position	AT (automatic)	ST (OFF)	DST (ON)
Display			

* When you have selected a new time zone, even if it was "AT (automatic)" before the time zone selection, it switches to "DST (ON)" or "ST (OFF)."

* If the DST (Daylight Saving Time) of the subdial is not correct, change over ON/OFF with reference to "Set the DST (Daylight Saving Time) of the sub-dial." P. 29 in the operation

2.

3 Push the crown back in

The seconds hand returns to the time display mode. The multi-function indicator hand returns to display the day of the week.

* If the energy level is low, the day of the week is not displayed, and the watch returns to a charging status display of "low."

* The buttons cannot be operated while the hour and minute hands, multi-function indicator hand, or sub-dial is moving.

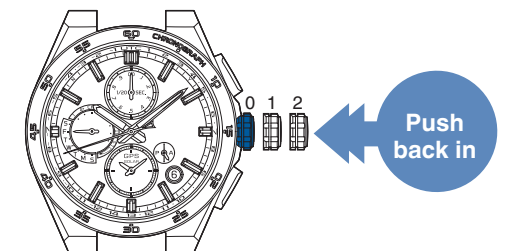

■ Set the DST (Daylight Saving Time) of the sub-dial.

DST (Daylight Saving Time) can be manually set.

* Normally, the multi-function indicator's DST (Daylight Saving Time) is not changed to "AT (automatic)" if the sub-dial is adjusted via manual time zone selection. Turn DST (Daylight Saving Time) manually on or off, according to whether DST (Daylight Saving Time) is implemented or not.

* It is unnecessary to do settings for DST (Daylight Saving Time) if DST = "AT (automatic)" is set in the sub-dial when the time for the main-dial and the sub-dial has been changed.

1 Pull out the crown to the second click

The multi-function indicator hand moves to indicate the DST (Daylight Saving Time) setting of the sub-dial.

The seconds hand displays the current time zone for the sub-dial.

< When DST (Daylight Saving Time) setting is OFF >

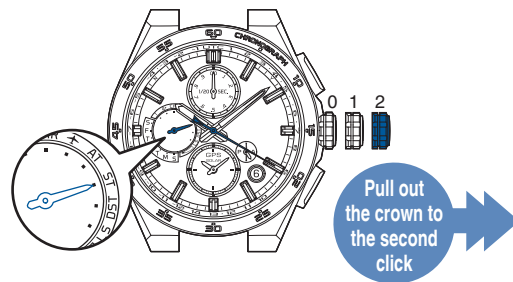

2 Continue to press Button A (3 seconds)

The multi-function indicator hand moves to point to "DST", and the sub-dial hour and minute hands advance by one hour.

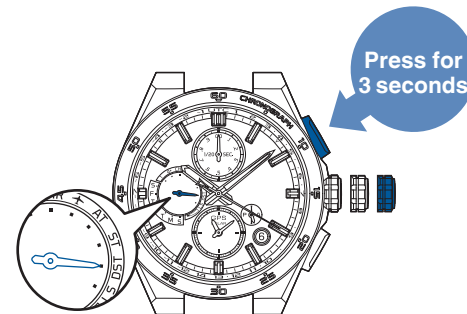

* In the Lord Howe Island time zone in Australia, the time is advanced by 30 minutes while DST (Daylight Saving Time) is in effect. This watch corresponds to DST in Lord Howe Island time zone.

3 Push the crown back in

The seconds hand returns to the time display mode.

The multi-function indicator hand returns to display the day of the week.

* If the energy level is low, the day of the week is not displayed, and the watch returns to a charging status display of "low."

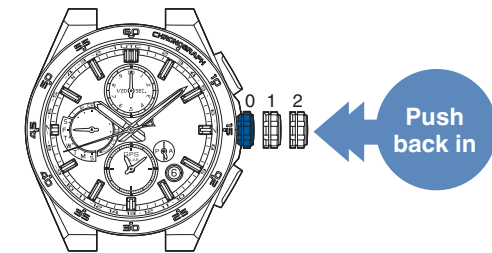

■ Turn OFF DST (Daylight Saving Time)

Carry out operation of **1** to **3** in the state where DST (Daylight Saving Time) setting is ON.

In operation of **2**, adjust the multi-function indicator hand to the "ST (OFF)" position as shown in the figure at the right.

The hour and minute hands return by one hour.

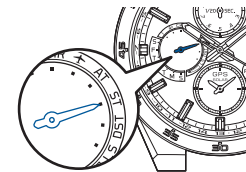

Switching between the main-dial and sub-dial (Time Transfer Function)

Your watch can switch between its main-dial and sub-dial.

Both the conditions for DST (Daylight Saving Time) set in the main-dial and the conditions for DST (Daylight Saving Time) set in the sub-dial switch.

This comes in handy in the following situations.

- Matching the main-dial to the time for the time zone set in the sub-dial
- To use your watch, adjust the main-dial to the local time, and then, after returning home, restore the main-dial to the sub-dial's Japan Standard Time

How to switch the main-dial and sub-dial

1 Press and hold buttons A and B at the same time (1 second)

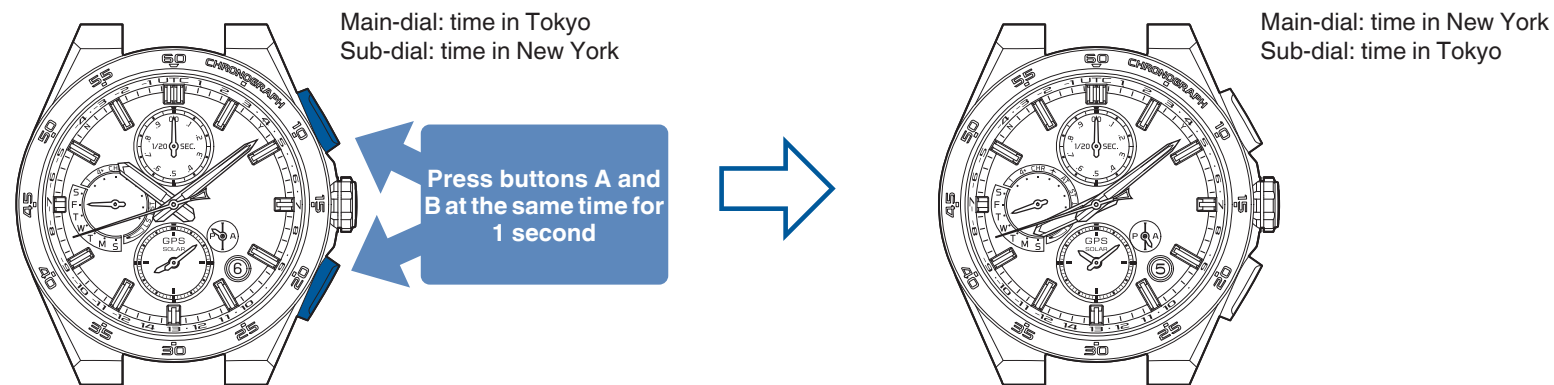

The seconds hand indicates the time zone for the main-dial that was switched. The multi-function indicator hand indicates the setting status for DST (Daylight Saving Time) of the main-dial that was switched. Afterward, the main-dial's hour and minute hands, sub-dial, and date switch.

Finally, the seconds hand returns to the time display, and the multi-function indicator hand returns to the day of the week display (or the charging status display).

* The buttons cannot be operated while the hour and minute hands, multi-function indicator hand, or sub-dial is moving.

Automatic time adjustment

This watch can be set to the precise current time by automatically receiving GPS signals by exposure to bright light outdoors under an open sky to adjust the time.

In addition, when the watch is concealed under a sleeve and the dial is not exposed to sufficient light even if outdoors under an open sky, the watch stores the time of the previous successful manual time adjustment (or time zone adjustment), and automatically starts time adjustment at the same time.

* In a place without good visibility, GPS signals cannot be received. → Place where GPS signals can be easily received/Place where GPS signals cannot be received [P. 18](#)

* If the energy is sufficiently charged, automatic reception will be performed every day.

* The automatic time adjustment is performed at most twice per day (At the time of sensing light, and at the time of previous successful manual time adjustment, it is performed maximum once for each). Even if the reception fails, it may be performed one more time, according to the conditions.

* Since only automatic time adjustment by sensing light will be performed under factory default settings, before using the watch for the first time, please succeed the manual time adjustment during the time zone when you will normally stay for a long time under the open sky where it is easy to receive signals.

* The time zone is not adjusted in the automatic time adjustment.

When the region where the watch is used is changed, please carry out time zone adjustment. How to adjust the time zone. → How to adjust the time zone [P. 22](#)

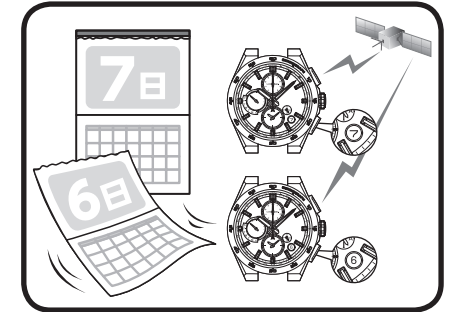

< When it is difficult to exposure to light sufficiently >

Even if outdoors under an open sky, when the watch is concealed under a sleeve in winter time, etc., in an area where the daylight hours are short, or when the watch is not likely to be exposed to sufficient light for a long time due to bad weather, the watch is designed to allow for automatic time reception at the time when the manual time adjustment was successful the last time.

When the watch is exposed to the operating environment above, automatic time adjustment is likely to be successful by making manual time adjustment successful in time periods where the watch is frequently used in a place where GPS signals can be easily received under an open sky.

→ How to manually adjust the time [P. 24](#)

However, as the watch judges to start automatic time adjustment taking into consideration the following conditions, the watch does not necessarily start automatic time adjustment by exposure to bright light or at the time when the manual time adjustment was successful the last time.

- Charging status
- Past reception status

* When the multi-function indicator hand points to "low," or in the in-flight mode (✈), automatic time adjustment does not work.

When the indicator hand points to "low," charge the watch by exposing it to light.

→ How to charge the watch [P. 16](#)

→ Check the charging status [P. 14](#)

* When the energy is reduced, the period for which automatic time adjustment is not performed becomes longer. Keep in mind to charge the watch regularly.

* If the time zone adjustment or manual time adjustment is performed before the automatic time adjustment is started, the automatic time adjustment is not performed on that day.

When boarding (in-flight mode (✈))

□ In-flight mode (✈)

Set to the in-flight mode (✈) where the reception may influence operation of other electronics devices in an airplane, etc.

In the in-flight mode (✈), the GPS signal reception (time zone adjustment, manual time adjustment, and automatic time adjustment) does not work.

< In-flight mode (✈) >

The multi-function indicator hand points to ✈.

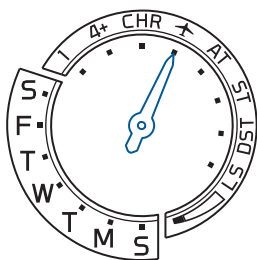

* When the in-flight mode (✈) is reset, the multi-function indicator hand indicates the day of the week (or the energy level).

□ Set to the in-flight mode (✈).

1 Pull out the crown to the first click

The seconds hand moves to display the currently set time zone.

The multi-function indicator hand indicates DST (Daylight Saving Time) setting.

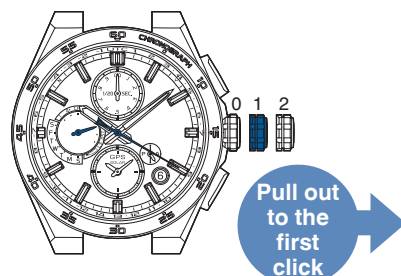

2 Continue to press Button B (3 seconds)

The multi-function indicator hand displays the in-flight mode (✈). (5 seconds)

Afterward, it indicates the DST (Daylight Saving Time).

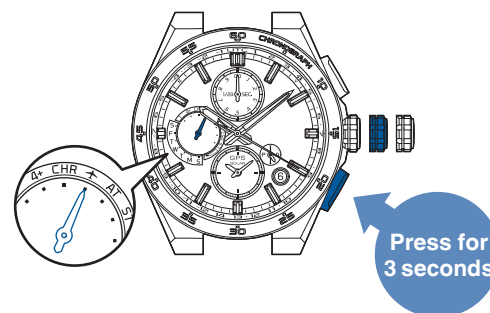

3 Push the crown back in

The multi-function indicator hand returns to display the in-flight mode (✈).

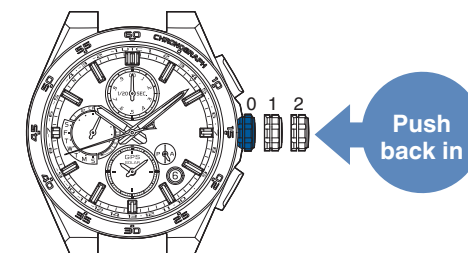

When the in-flight mode (✈) is set, the multi-function indicator hand does not indicate the day of the week.

* Note that by rotating the crown after **1** and **2** are completed, the time zone will switch.
→ To set the watch to the local time of the destination in an airplane, etc.
(Manual time zone setting) P. 25

□ Reset the in-flight mode (✈).

Turn off the in-flight mode when leaving an airplane, etc.

If it is not turned off, the watch will not be able to receive GPS signals.

Carry out operation **1** to **3**.

2 will make the multi-function indicator hand point to “4+”, indicating that in-flight mode has been turned off. (5 seconds)
Afterward, it indicates the DST (Daylight Saving Time).

3 will make the multi-function indicator hand display the day of the week, and the in-flight mode (✈) will be turned off.

* If the energy level is low, the day of the week is not displayed, and the watch returns to a charging status display of “low.”

Leap second (Automatic leap second reception function)

□ Leap second

The leap second is to compensate for deviations from the universal time (UT) which is astronomically determined and the “International Atomic Time (TAI).

“1 second” may be added (deleted) once a year or every few years.

□ Automatic leap second reception function

A leap second is automatically added by receiving “leap second data” from GPS signals at the time of leap second addition (deletion).

* “Leap second data” includes information about future leap second addition and current leap second data.

□ Receiving leap second data

When the GPS signal reception (automatic time adjustment, manual time adjustment, or time zone adjustment) is performed on or after December 1st and June 1st, the multi-function indicator hand may display as shown at the right.

When the leap second data reception is completed, the multi-function indicator hand returns to display the day of the week (or the charging status). Use the watch as it is.

* The leap second data reception is performed every half a year regardless of leap second addition.

After the completion of time adjustment (automatic time adjustment or manual time adjustment), up to 18 minutes may be required until receipt of leap second data is complete.

Receiving the leap second data

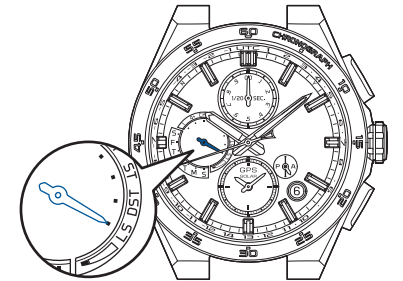

When GPS signals are received under the following conditions, the leap second data reception is also started.

- GPS signals have not been received for a long time
- Leap second data reception has failed

With GPS signal reception, leap second data reception will be performed again. This will continue until leap second data reception is successful. Confirm the result (success or failure) of the leap second data reception.

→ Check whether leap second data reception was successful [P. 34](#)

Check whether leap second data reception was successful

The reception result (success or failure) of the regular leap second data reception is displayed for 5 seconds.

1 Press Button A once and then release it

The seconds hand and multi-function indicator hand display the reception result.

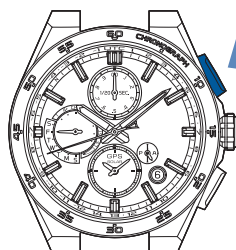

Press and then release

* When Button A is kept pressed, the watch enters the Manual time adjustment operation.

2 The result of the reception is displayed

The seconds hand displays the result of the GPS signal reception (time adjustment or time zone adjustment).

The multi-function indicator hand points to "1" or "4+" which shows "time adjustment" or "time zone adjustment."

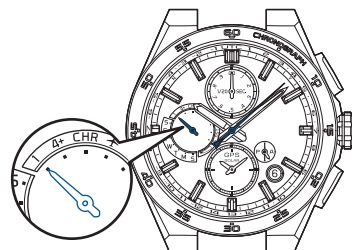

* The indicator hand points to "4+" as a result of time zone adjustment.

Seconds hand: Reception result (success/failure)

Result	Successful	Failed
Display		
Position	Y: 8-second position	N: 52-second position

* After 5 seconds have elapsed or when Button B is pressed, the watch returns to the time display mode.

3 Press Button A and then release it while the result of the reception is displayed (for 5 seconds) in step 2

The seconds hand displays the result of the leap second data reception (successful / failed).

The multi-function indicator hand displays "LEAP SEC." of the leap second data reception.

Seconds hand

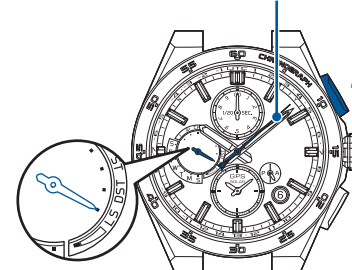

Press and then release

Seconds hand: Reception result (success/failure)

Result	Successful	Failed
Display		
Position	Y: 8-second position	N: 52-second position

* After 5 seconds have elapsed or when Button B is pressed, the watch returns to the time display mode.

When the leap second data reception result is Y (successful)

- The leap second data reception was successful. Use the watch as it is.

When the leap second data reception result is N (failed)

- The leap second data reception, periodically performed, has not been successful. It will be performed automatically with the next GPS signal reception (automatic time adjustment, manual time adjustment or time zone adjustment). Use the watch as it is.

* The leap second data is received on or after December 1st and June 1st.

* Even when the leap second data reception has not been successful, the time is correct until the leap second data is added (deleted).

Move to the outdoors where GPS signals can be easily received as necessary to receive GPS signals.

→ Place where GPS signals can be easily received/
Place where GPS signals cannot be received P. 18

How to use the stopwatch

Basic stopwatch functions

- The stopwatch can measure and read up to 11 hours, 59 minutes, and 59.95 seconds in 1/20-second increments.
- The display consists of four hands.
After 12 hours have passed, the stopwatch will stop and reset.
- The stopwatch 1/20-second hand stops at the 0-second position after operating for up to one minute.
When a split or stop operation is performed, the seconds are displayed.

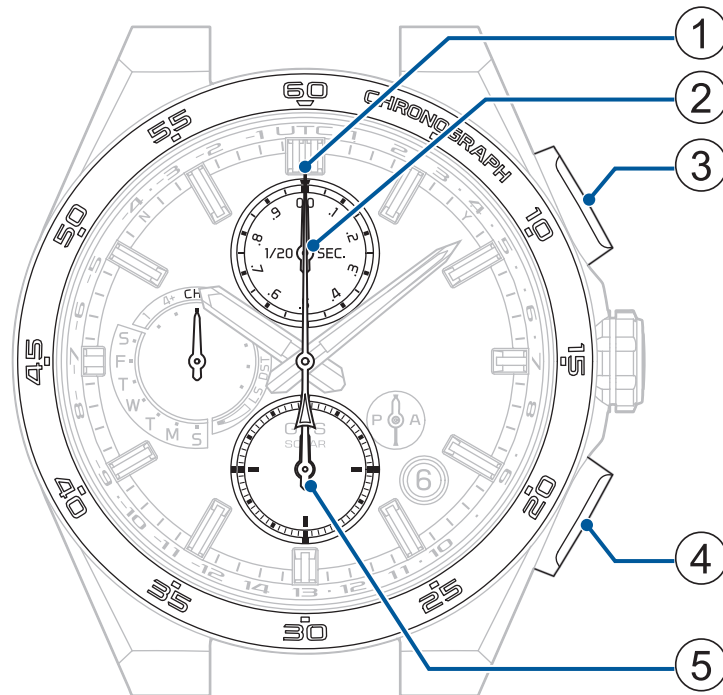

- ① Stopwatch seconds hand
- ② Stopwatch 1/20-second hand
- ③ Button A
- ④ Button B
- ⑤ Stopwatch hour and minute hands

* The AM/PM hands also move together, but they do not indicate the measured time.

Switching to stopwatch mode

1 Pull out the crown to the first click

The seconds hand moves to display the currently set time zone.

The multi-function indicator hand indicates DST (Daylight Saving Time) setting.

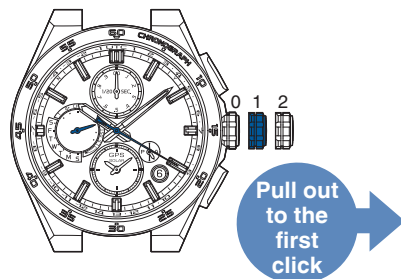

2 Press Button B and then release it

The multi-function indicator hand displays "CHR".

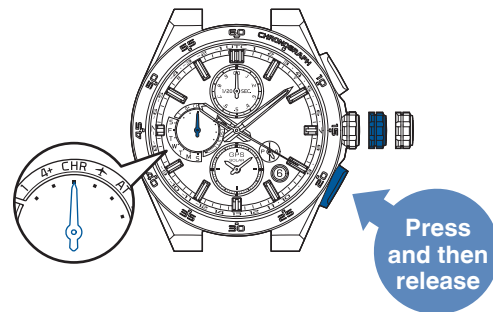

3 Push the crown back in

The watch will enter stopwatch mode.

The stopwatch hands (1/20-second, seconds, hour, and minute hands) return to the 0-second position.

* The 1/20-second hand goes around once.

The multi-function indicator hand continues to display "CHR".

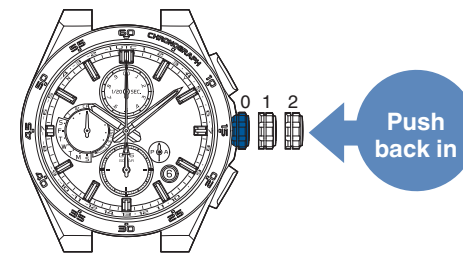

* Start measurement after the 1/20-second hand and the seconds hand return to the 0-second position.

The measurement will start even if the stopwatch hour and minute hands are being advanced rapidly.

Turning off stopwatch mode

Pulling out the crown and pushing it back in turns off stopwatch mode.

The multi-function indicator hand returns to display the day of the week.

* If the energy level is low, the day of the week is not displayed, and the watch returns to a charging status display of "low."

Normal use



When time is measured in cumulative total

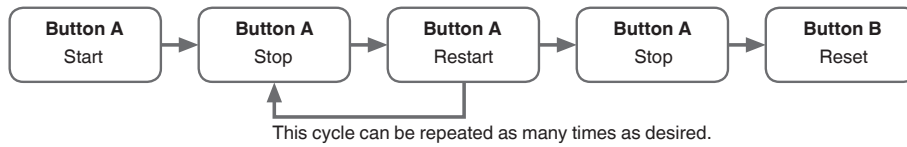

To measure the split time

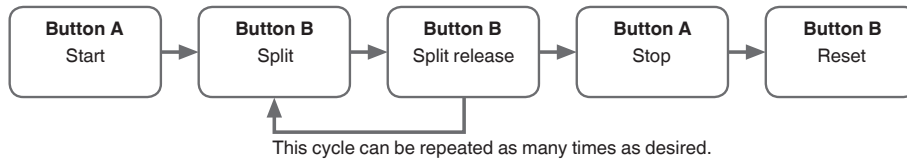

* When the stopwatch is in the “split” state, when the measured time reaches 12 hours, measurement will automatically terminate.

The split is reset and the stopwatch returns to 0 hours, 0 minutes, and 0 seconds.

When time is measured for two people

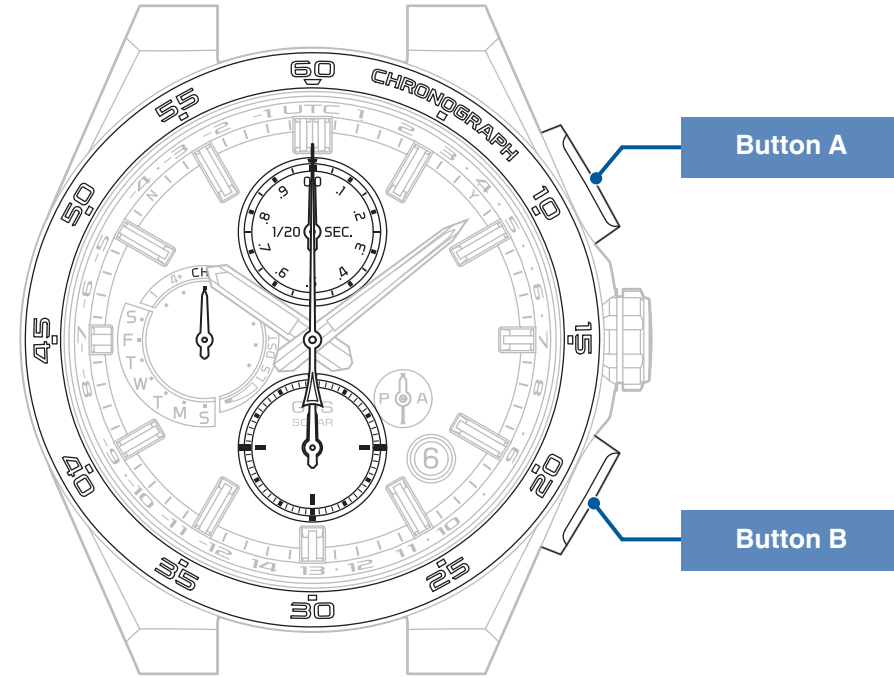
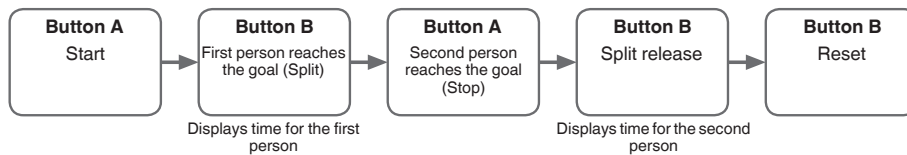

Resetting the stopwatch

● If the stopwatch hands are moving

- ① Press Button A to stop
- ② Press Button B to reset

● If the stopwatch hands are stopped, the following three situations are possible.

[Stopped in a stop state]

- ① Press Button B to reset

[Stopwatch measurement is in progress and the split display is active]

- ① Rapidly advance the stopwatch hands with Button B, then the stopwatch will enter a state of measurement.
- ② Press Button A to stop
- ③ Press Button B to reset

[Stop state with split display]

- ① Rapidly advance the stopwatch hands with Button B, then the stopwatch will stop.
- ② Press Button B to reset

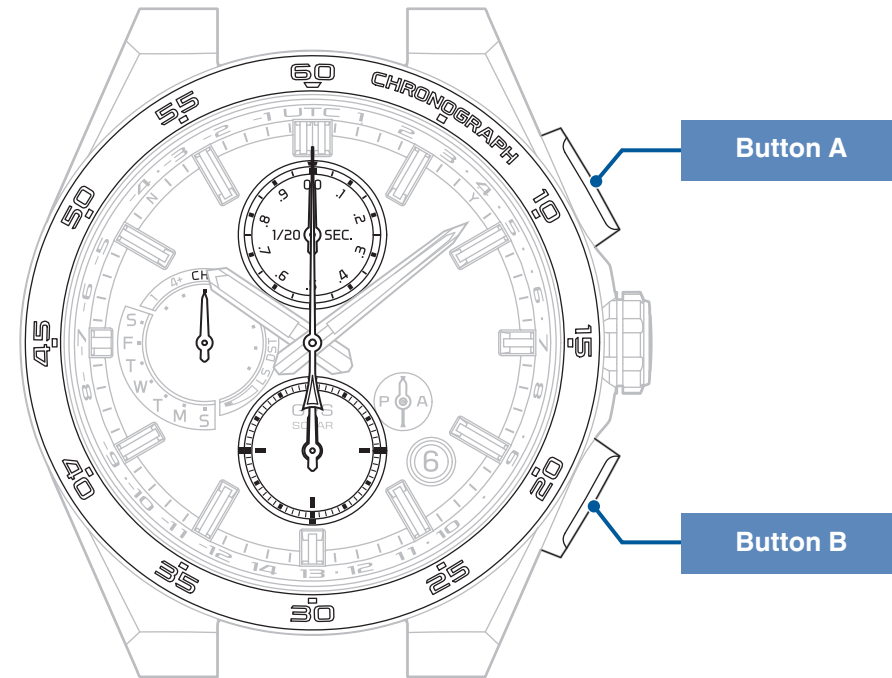

Seconds hand movement and watch state (energy depletion forewarning function)

Movement of the seconds hand shows the state of the watch (working functions).

2-second interval movement/5-second interval movement are brought about

When the energy stored in the watch runs low, the energy depletion forewarning function will work.

When the energy stored in the watch runs low, charge the watch by exposure to light. → How to charge the watch P. 16

* When the energy depletion forewarning function works, the watch does not operate even with operation of the buttons and crown.
(Be assured that it does not mean a failure)

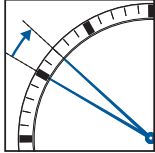
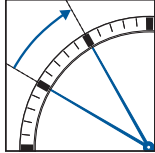
	2-second interval movement	5-second interval movement
State	The seconds hand moves at 2-second intervals. 	The seconds hand moves at 5-second intervals. 
Restriction on function/display	<ul style="list-style-type: none"> Reception is not started even with operation of GPS signal reception. Automatic time adjustment does not work. The stopwatch function does not work. 	<ul style="list-style-type: none"> The hour hand, minute hand, date, and sub-dial stop. Reception is not started even with operation of GPS signal reception. Automatic time adjustment does not work. The stopwatch function does not work.
Solution	<ol style="list-style-type: none"> First, charge the watch by exposure to light until the seconds hand moves at 1-second intervals. → How to charge the watch P. 16 Charge the watch until the multi-indicator hand returns to the day of the week display from a charging status display of "low." (If the energy level is "low", GPS signals cannot be received.) When the hand returns to the day of the week display, the energy level will be "middle" or "full." → Check the charging status P. 14 	<ol style="list-style-type: none"> Continue to charge the watch until the multi-indicator hand returns to the day of the week display from a charging status display of "low." → Check the charging status P. 14 Carry out time zone adjustment to set the time. → How to adjust the time zone P. 22

The seconds hand stops at the 15-second position/45-second position (Power save function)

When the watch is not exposed to light for a long time, the power save function will work.

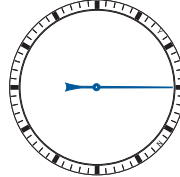
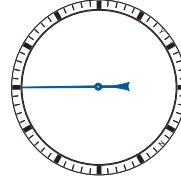
	Power Save 1	Power Save 2
State	The seconds hand stops pointing at the 15-second position. 	The seconds hand stops pointing at the 45-second position. 
Restriction on function/display	<ul style="list-style-type: none"> The hour hand, minute hand, date, and sub-dial stop. Automatic time adjustment is not performed. 	<ul style="list-style-type: none"> The hour and minute hands, date, and sub-dial stop. (the date displays "1", and the sub-dial displays 12:00 AM) Reception is not started even with operation of GPS signal reception. Automatic time adjustment is not performed. The multi-function indicator hand points to "low." The stopwatch function does not work.
Cause	When the watch is exposed to a state without receiving an adequate light source for 72 hours or longer.	When the watch is in an insufficient charging state for a long time.
Solution	<ul style="list-style-type: none"> When the watch is exposed to an adequate light source for more than 5 seconds, or when any button is pressed, it displays the current time again after the seconds hand is rapidly advanced. 	<ol style="list-style-type: none"> Charge the watch until the multi-indicator hand returns to the day of the week display from a charging status display of "low." → Check the charging status P. 14 Adjust the preliminary position for each hand. → Setting the preliminary position of the sub-dial, stopwatch 1/20-second hand, multi-function indicator hand, date, and hour/minute hands P. 52 Carry out time zone adjustment to set the time. → How to adjust the time zone P. 22

Power Save 2

* While the watch is being charged, the seconds hand moves at "5-second intervals." During the "5-second Interval Movement," the buttons cannot be operated.

* If the "Power Save 2" mode is prolonged, the stored power amount drops and the internal current time information stored will be lost.

Daily care

● The watch requires good daily care

- Do not wash the watch when its crown is in the extended position.
- Wipe away moisture, sweat or dirt with a soft cloth.
- After soaking the watch in seawater, be sure to wash the watch in clean pure water and wipe it dry carefully.
Do not pour running water directly from a faucet onto the watch. Put some water into a bowl first, and then soak the watch in the water to wash it.

* If your watch is rated as “non-water resistant” or “water resistant for daily use,” do not wash the watch.
→ Performance and caliber / case number P. 40
→ Water resistant performance P. 40

● Turn the crown from time to time

- In order to prevent corrosion of the crown, turn the crown from time to time.

● Press the button once in a while

- Press the button once in a while to prevent corrosion of the button.

Performance and caliber / case number

The case back shows the caliber and performance of your watch

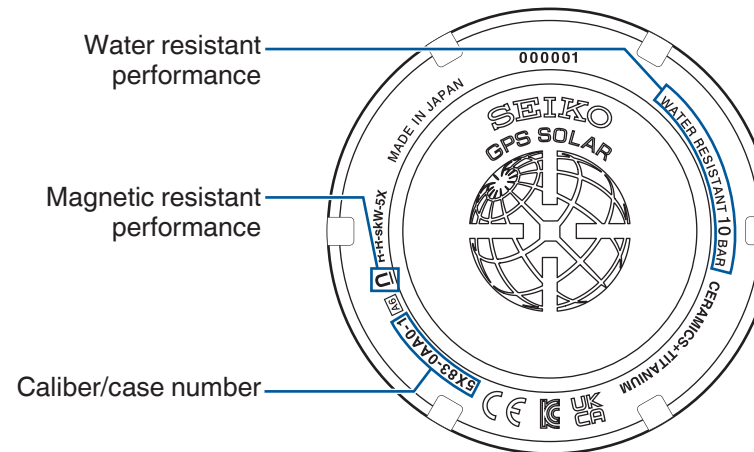

- **Water resistant performance**
Refer to P. 40
- **Magnetic resistant performance**
Refer to P. 41

- **Caliber/case number**
The number to identify the type of your watch.

* The above illustration is provided as an example, therefore it may not be exactly the same as your watch.

Water resistant performance

Refer to the table below for the description of each degree of water resistant performance of your watch before using.

Indication on the case back	Water resistant performance	Conditions of Use
WATER RESISTANT 10 (20) BAR	Water resistance for everyday life at 10 (20)-BAR water resistant	This watch can be used for swimming and other such sports. The watch is suitable for diving without an air cylinder.

Magnetic resistance

Affected by nearby magnetism, a watch may temporarily gain or lose time or stop operating.

* This watch will automatically adjust the position of the hands if the time is rendered incorrect through magnetism, through the automatic hand position alignment function.

(P. 51)

This watch has magnetic resistance which complies with ISO “Magnetic resistant watches.”

CAUTION

Keep the watch more than 5 cm away from magnetic products.

If the watch becomes magnetized and its accuracy deteriorates to an extent exceeding the specified rate under normal use, the watch needs to be demagnetized. In this case, you will be charged for demagnetization and accuracy readjustment even if it happens within the guarantee period.

The reason why a watch is affected by magnetism

The built-in motor is provided with a magnet, which may be influenced by a strong external magnetic field.

Examples of common magnetic products that may affect watches

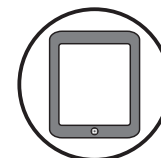
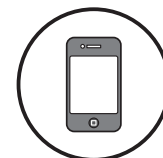

Smartphone, cellular phone, tablet terminal
(Speaker, magnet of cover)

AC adapter

Bag
(With magnet buckle)

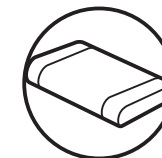
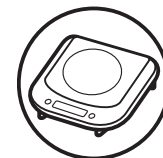

AC-powered shaver

Magnetic cooking device

Portable radio
(Speaker)

Magnetic necklace

Magnetic health pillow

Band

The band touches the skin directly and becomes dirty with sweat or dust. Therefore, lack of care may accelerate deterioration of the band or cause skin irritation or stain on the sleeve edge.

The watch requires a lot of attention for long usage.

● Metallic band

- Moisture, sweat or soil will cause rust even on a stainless steel band if they are left for a long time.
- Lack of care may result in a rash or cause a yellowish or gold stain on the lower sleeve edge of shirts.
- Wipe off moisture, sweat or soil with a soft cloth as soon as possible.
- To clean the soil around the joint gaps of the band, wipe it out in water and then brush it off with a soft toothbrush.
(Protect the watch body from water splashes by wrapping it up in plastic wrap etc.)
Clean it off with a soft cloth.
- Because some titan bands use pins made of stainless steel, which has outstanding strength, rust may form in the stainless steel parts.
- If rust advances, pins may poke out or drop out, and the watch case may fall off the band, or the clasp may not open.
- If a pin is poking out, personal injury may result. In such a case, refrain from using the watch and request repair.

● Leather band

- A leather band is susceptible to discoloration and deterioration from moisture, sweat and direct sunlight.
- Wipe off moisture and sweat as soon as possible by gently blotting them up with a dry cloth.
- Do not expose the watch to direct sunlight for a long time.
- Please take care when wearing a watch with light-colored band, as dirt is likely to show up.
- Refrain from wearing a leather band watch other than Aqua Free bands while bathing, swimming, and when working with water even if the watch itself is water resistant enforced for daily use (10-BAR/20-BAR water resistant).

● Polyurethane band

- A polyurethane band is susceptible to discoloration from light, and may be deteriorated by solvent or atmospheric humidity.
- Especially a translucent, white, or pale colored band easily adsorbs other colors, resulting in color smears or discoloration.
- Wash out dirt in water and clean it off with a dry cloth.
(Protect the watch body from water splashes by wrapping it up in plastic wrap etc.)
- When the band becomes less flexible, have the band replaced with a new one. If you continue to use the band as it is, the band may develop cracks or become brittle over time.

● Silicone band

- As for material characteristics, the band is easily dirtied, and may be stained and discolored. Wipe off dirt with a wet cloth or cleaning tissue.
- Unlike bands of other materials, cracks may result in the band being cut. Take care not to damage the band with an edged tool.

Notes on skin irritation and allergy	Skin irritation caused by a band may result from various factors such as allergy to metals or leathers, or skin reactions against friction on dust or the band itself.
Notes on the length of the band	Adjust the band to allow a little clearance with your wrist to ensure proper airflow. When wearing the watch, leave enough room to insert a finger between the band and your wrist. 

How to use an easy adjust type clasp

Some bands are provided with an easy adjust type clasp for fine adjustment of the band's length.

If the clasp of the watch you purchased is of this type, please refer to the following instructions.

* The band can be lengthened by up to about 5 mm. This is useful if the band feels too tight or is uncomfortable for some reason.

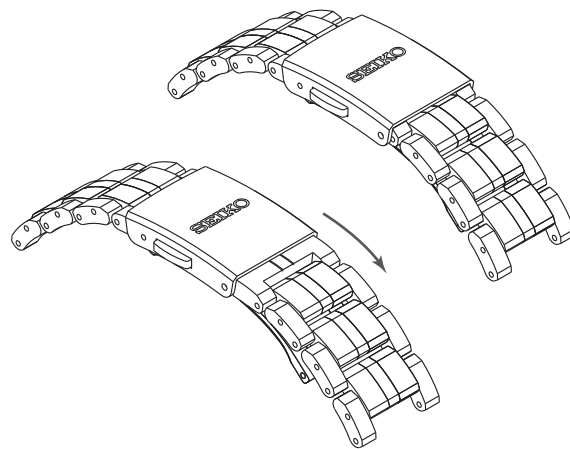

● How to wear the band (Opening and closing the clasp)

1 Lightly press the push buttons to open the clasp.

* Note that pressing the push buttons too firmly (deeply) actuates the adjuster, which lengthens the band.

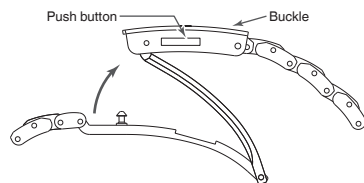

2 Fasten the clasp by pressing the frame of the buckle.

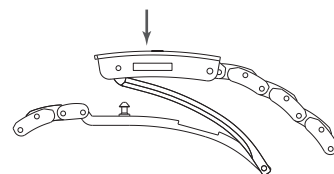

● How to adjust the length of the band

1 You can lengthen the band by up to about 5 mm (2 stages) by firmly pressing the push buttons from both sides to actuate the adjuster.

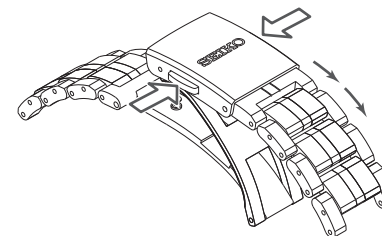

2 Fasten the clasp by pressing the frame of the buckle.

* Even while the clasp is closed, you can still retract the length of band extended by the adjuster.

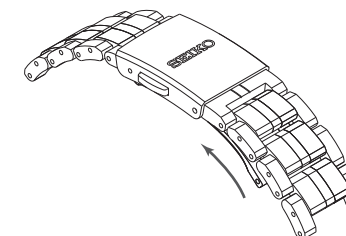

* The above illustrations are provided as examples. Some details may differ depending on the model.

How to use an adjustable three-fold clasp

Some bands are provided with an adjustable three-fold clasp.

If the clasp of the watch you purchased is of this type, please refer to the following instructions.

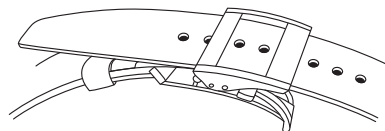

● How to wear or take off the watch

- 1 While pressing the push buttons on both sides of the flap, pull the band out of the movable loop and fixed loop. Then open the clasp.

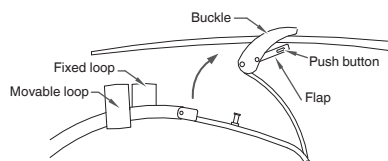

- 2 Place the tip of the band into the movable loop and fixed loop, and fasten the clasp by pressing the frame of the buckle.

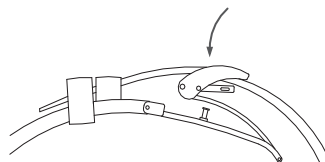

● How to adjust the length of the band

- 1 While pressing the push buttons on both sides of the flap, pull the band out of the movable loop and fixed loop. Then open the clasp.

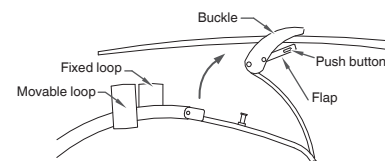

- 2 Press the push buttons again to unfasten the flap.

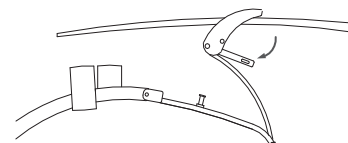

- 3 Pull the pin out of an adjustment hole of the band. Slide the band to adjust its length and find an appropriate hole. Place the pin into the hole.

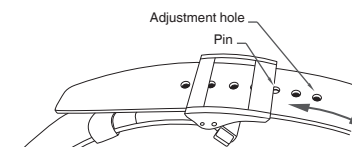

- 4 Fasten the flap.

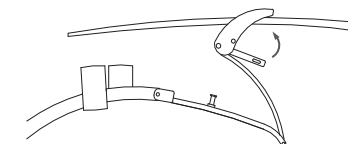

* The above illustrations are provided as examples. Some details may differ depending on the model.

How to use an adjustable three-fold clasp (Pointed tip diving type)

The rubber bands and some leather bands are provided with an adjustable three-fold clasp (Pointed tip diving type) of the type where the pointed tip of the band dives downward as shown in the figure.

If the clasp of the watch you purchased is of this type, please refer to the following instructions.

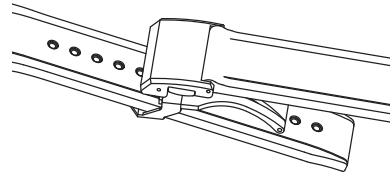

● How to wear or take off the watch

- 1 Open the clasp and pull upward by pressing the push buttons on both sides of the buckle.

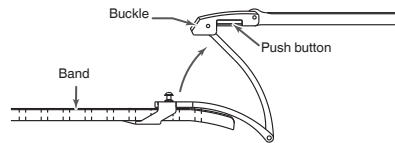

- 2 Fasten the clasp by pressing the frame of the buckle.

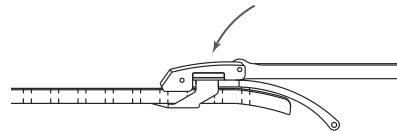

● How to adjust the length of the band

- 1 Open the band clasp by pushing the buttons on both sides of the clasp.

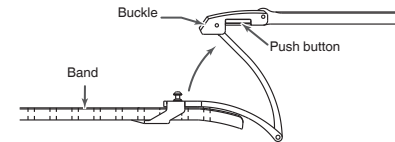

- 3 Slide the band to the right and left and at an appropriate length, push the pins firmly into the adjustment holes again at those 2 locations.

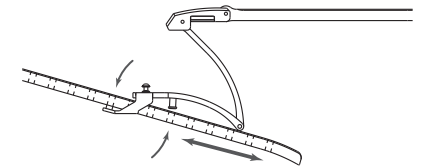

- 2 Pull the pins out of the adjustment holes at both locations.

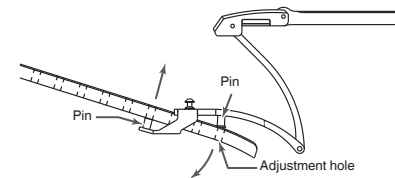

* The above illustrations are provided as examples. Some details may differ depending on the model.

Lumibrite

If your watch has Lumibrite

Lumibrite is a luminous paint that absorbs the light energy of sunlight and lighting apparatuses in a short time and stores it to emit light in the dark. For example, if exposed to a light of more than 500 lux for approximately 10 minutes, Lumibrite can emit light for 3 to 5 hours. Please note, however, that, as Lumibrite emits the light it stores, the luminance level of the light decreases gradually over time. The duration of the emitted light may also differ slightly depending on such factors as the brightness of the place where the watch is exposed to light and the distance from the light source to the watch.

* In general, when coming from a place that is bright to a place that is dark, it takes human eyes some time to adapt to the darkness making it difficult to see objects initially. (Dark adaptation)

* Lumibrite is luminous paint that stores and emits light, which is harmless to human beings and the environment, containing no toxic materials such as radioactive substances.

<Brightness levels>

Condition		Illumination
Sunlight	Fine weather	100,000 lux
	Cloudy weather	10,000 lux
Indoor (Window-side during daytime)	Fine weather	More than 3,000 lux
	Cloudy weather	1,000 to 3,000 lux
	Rainy weather	Less than 1,000 lux
Lighting apparatus (40-watt daylight fluorescent light)	Distance to the watch: 1 m	1,000 lux
	Distance to the watch: 3 m	500 lux (Average room luminance)
	Distance to the watch: 4 m	250 lux

Power Source

The battery used in this watch is a special secondary battery, which is different from ordinary batteries.

Unlike an ordinary silver oxide battery, the secondary battery does not require periodic replacement.

The capacity or charging efficiency may gradually lower due to long-term use or operating environment.

In addition, long-term use may shorten the charge duration due to wear, contamination, lubricant deterioration of mechanical parts, etc. Request repair when the performance lowers.

WARNING

Notes on replacing the secondary battery

- Do not remove the secondary battery from the watch. Replacement of the secondary battery requires professional knowledge and skill. Please ask the retailer from whom the watch was purchased for replacement of the secondary battery.
- Installation of an ordinary silver oxide battery can generate heat that can cause bursting and ignition.

- * Overcharge prevention function

When the secondary battery is fully charged, the overcharge prevention function is automatically activated to avoid further charging.

There is no need to worry about damage caused by overcharging no matter how much the secondary battery is charged in excess of the “time required for fully charging the watch”.

- * Refer to “Standard Charging Time” P. 16 to check the time required for fully charging the watch.

WARNING

Notes on charging the watch

- When charging the watch, do not place the watch in close proximity to an intense light source such as lighting equipment for photography, spotlights or incandescent lights, as the watch may be excessively heated resulting in damage to its internal parts.
- When charging the watch by exposure to direct sunlight, avoid places that easily reach high temperatures, such as a car dashboard.
- Always keep the watch temperature under 60°C.

- * When the watch has not been charged for a long time

If the watch has not been charged for a long time, the watch will be completely discharged and no longer able to be charged. In this case, consult the retailer from whom the watch was purchased.

After sales service

● Notes on guarantee and repair

- Contact the retailer from whom the watch was purchased or SEIKO CUSTOMER SERVICE CENTER for repair or overhaul.
- Within the guarantee period, present the certificate of guarantee to receive repair services.
- Guarantee coverage is provided in the certificate of guarantee. Read carefully and retain it.
- For repair services after the guarantee period has expired, if the functions of the watch can be restored by repair work, we will undertake repair services upon request and payment.

● Replacement with functional parts

- Normally, the warranty period for this watch's replacement parts is a standard 7 years. Replacement parts are parts for which repair is necessary to maintain the time function.
- Please keep in mind that if original parts are not available, they may be replaced with substitutes whose outward appearance may differ from the originals.

● Inspection and adjustment by disassembly and cleaning (Overhaul)

- Periodic inspection and adjustment by disassembly and cleaning (overhaul) is recommended approximately once every 3 to 4 years in order to maintain optimal performance of the watch for a long time. According to use conditions, the oil retaining condition of your watch mechanical parts may deteriorate, abrasion of the parts may occur due to contamination of oil, which may ultimately lead the watch itself to stop.
As the parts such as gasket may deteriorate, water-resistant performance may be impaired due to intrusion of perspiration and moisture.
Please contact the retailer from whom the watch was purchased for inspection and adjustment by disassembly and cleaning (overhaul). For replacement of parts, please specify "SEIKO GENUINE PARTS". When asking for inspection and adjustment by disassembly and cleaning (overhaul), make sure that the gasket and push pin are also replaced with new ones.
- When your watch is inspected and adjusted by disassembly and cleaning (overhauled), the movement of your watch may be replaced.

When the watch is unable to receive GPS signals



■ Points to be checked

When the watch does not start receiving or is unable to receive GPS signals even with operation of GPS signal reception, the following can be considered.

● Reception is not started even with operation of GPS signal reception (time zone adjustment/manual time adjustment).

- Check the multi-function indicator hand position.

✕ Reception is not allowed

Multi-function indicator display	Charging status	In-flight mode (✕)
	low	
Display		
Solution	Expose the watch to light and charge the watch until the hand returns to the day of the week display from a charging status display of "low." → How to charge the watch P. 16 → Check the charging status P. 14	Reset the in-flight mode (✕). → Reset the in-flight mode (✕). P. 32

● Reception is not possible even with operation of GPS signal reception (time zone adjustment/manual time adjustment) (The reception result is displayed as "N.")

- Move to a place where GPS signals can be easily received.
→ Place where GPS signals can be easily received/Place where GPS signals cannot be received P. 18

● The seconds hand stops at the 45-second position before the reception is completed (The watch enters the power save 2 state)

- If GPS signal reception is performed under low temperatures (0°C or less) in a state where the charging capacity and/or charging efficiency are lowered, the reception will be stopped, and the watch may enter the power save 2 state.
GPS signal reception consumes a significant amount of energy. Keep in mind to charge the watch regularly by exposure to light.→ How to charge the watch P. 16
If this occurs frequently, consult the retailer from whom the watch was purchased.

Adjust the time under a condition in which the watch is unable to receive GPS signals (Manual time setting)

■ Manual time setting

When a problem cannot be solved even by carrying out the "Points to be checked", or time is gained or lost under a condition in which the watch is unable to receive GPS signals and the watch is unable to receive GPS signals continuously, set the time manually.

How to manually set the time

- When using the watch again under a condition in which the watch is able to receive GPS signals, receive GPS signals to set the time.
- When adjusting the time, the date will also be adjusted.

1 Pull out the crown to the second click

The seconds hand moves to display the sub-dial of the currently set time zone.

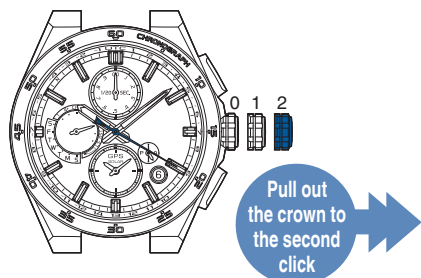

2 Continue to press Button B (6 seconds) until the seconds hand moves to the 0 position, and then release it

* Although the seconds hand moves to the 36 seconds position after pressing Button B for 3 seconds, continue to press it.

The seconds hand moves to stop at the 0-second position.

The watch enters the manual time setting mode.

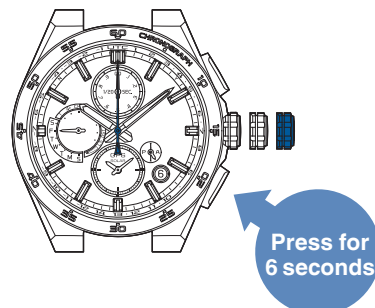

* When the watch enters the manual time setting mode, the reception result will be displayed as "N", since the reception results data will be lost.

3 Turn the crown to set the time

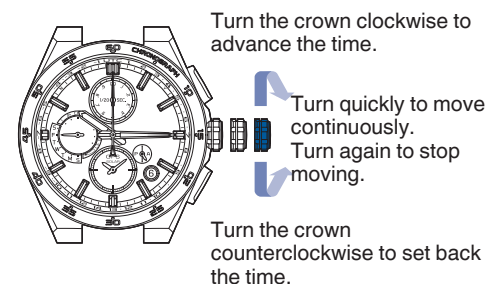

* When it has moved continuously for 12 hours, it will stop.

Turn the crown to continue setting.

* The point in which the date changes is at 0:00 AM (12:00 PM). Set the time taking into consideration AM or PM.

4 Push the crown back in (simultaneously with a time signal)

Operation has been completed.

The watch resumes its normal movement.

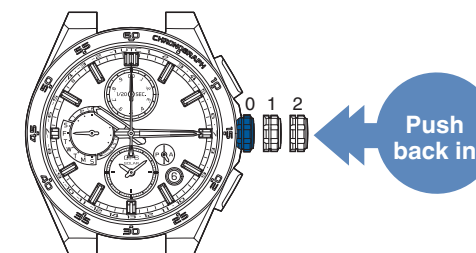

* Also the sub-dial is corrected in accordance with the corrected time at this time.

* Even if GPS signals cannot be received, the watch can be used with the same accuracy as a normal quartz watch. (at loss/gain ± 15 seconds per month on average)

* If the watch receives GPS signals after manual time setting, it displays the received time.

When the sub-dial, stopwatch 1/20-second hand, multi-function indicator hand, date, or hour/minute/seconds hand position is misaligned

Points to be checked

● Reception was successful (the reception result is displayed as “Y”), but time has been gained or lost.

- **Check the time zone setting.**
→ **Check the time zone and DST (Daylight Saving Time) settings** P. 27

If the currently set time zone does not correspond to the region where you are, set the time zone by either of the following operations.

Place where GPS signals can be easily received → **How to adjust the time zone** P. 22

Place where GPS signals cannot be received → **How to manually set the time zone** P. 25

- **Check DST (Daylight Saving Time) setting.**
→ **Check the time zone and DST (Daylight Saving Time) settings** P. 27

If DST (Daylight Saving Time) setting does not correspond to the addition conditions of DST (Daylight Saving Time) of the region where you are, set DST (Daylight Saving Time) with reference to “Turn ON DST (Daylight Saving Time)” P. 26.

- **Automatic time adjustment may not get activated for a few days.**
→ **Automatic time adjustment** P. 31

The automatic time adjustment function is unlikely to be activated due to low energy stored in the watch or depending on the environment.

To immediately adjust the time, refer to “How to adjust the time zone” P. 22.

Preliminary position

When the watch is unable to display the precise time or date, or the stopwatch 1/20-second hand or multi-function indicator hand does not point to the correct position even when it has successfully received GPS signals, the preliminary position may be misaligned.

The preliminary position is misaligned due to the following reasons.



Strong impact such as dropping or hitting

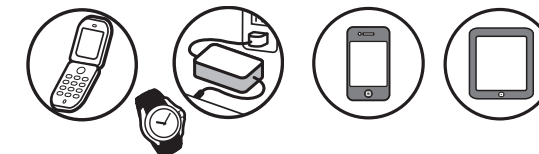

Things around you which generate magnetism
→ Examples of common magnetic products that may affect watches P. 41

When comparing the state of “Misaligned Preliminary Hand Position” to that of a weight scale, it is like “a scale which is unable to display the correct weight because its needle is not set to the zero position before weighing.”

Setting the preliminary position of the hour, minute, and seconds hands (automatic hand position alignment function)

The “automatic hand position alignment function” automatically adjusts the hour, minute, and seconds hands when the preliminary positions are incorrect.

The automatic hand position alignment function acts once per 12 hours for the hour hand (at noon and midnight), once per hour for the minute hand, and once per 10 minutes for the seconds hand.

* This function works when the preliminary hand position is misaligned due to external factors such as strong impact or magnetic influence.

It does not work to adjust accuracy of the watch or slight misalignment which may occur during the manufacturing process.

* The preliminary positions of the hour and minute hands can be adjusted manually.

→ Setting the preliminary position of the sub-dial, stopwatch 1/20-second hand, multi-function indicator hand, date, and hour/minute hands P. 52

Setting the preliminary position of the sub-dial, stopwatch 1/20-second hand, multi-function indicator hand, or date

Since the preliminary positions of the sub-dial, stopwatch 1/20-second hand, multi-function indicator hand, and date are not automatically adjusted, they must be adjusted manually.

→ Setting the preliminary position of the sub-dial, stopwatch 1/20-second hand, multi-function indicator hand, date, and hour/minute hands P. 52

□ Preliminary position of this watch

The preliminary position of the date is “1” (1st).

The preliminary position of the multi-function indicator hand is a charging status display of “low.”

The preliminary position of the hour/minute hands is “12:00 AM”.

The preliminary position for the sub-dial and the AM/PM hand is “12:00 AM”.

The preliminary position of the stopwatch 1/20-second hand is 0.00 seconds.

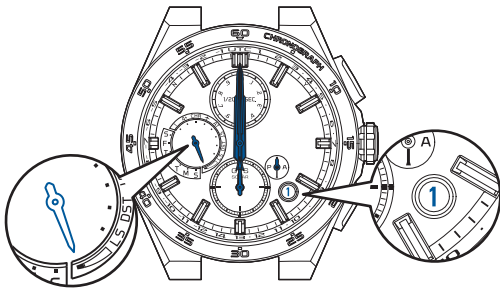

□ Setting the preliminary position of the sub-dial, stopwatch 1/20-second hand, multi-function indicator hand, date, and hour/minute hands

1 Pull out the crown to the second click

The seconds hand moves to display the sub-dial of the currently set time zone.

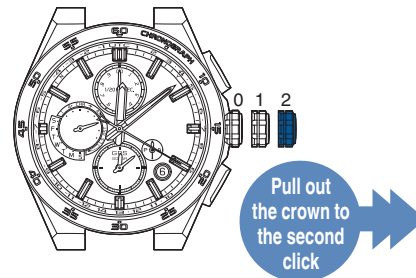

2 Continue to press Button B (3 seconds)

The watch enters the mode to adjust the preliminary position of the sub-dial.

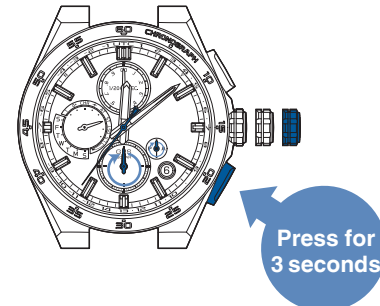

The seconds hand stops at the 36-second position. The sub-dial and the AM/PM hand turn and stop to indicate the preliminary position.

3 Turn the crown to adjust the sub-dial and AM/PM hand to “12:00 AM”

* When the sub-dial and AM/PM hand are “12:00 AM”, go to operation 4.

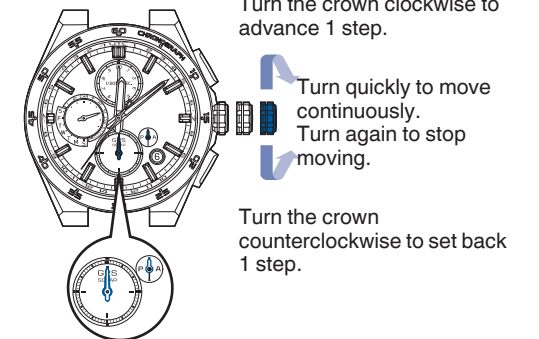

At this time, the sub-dial and AM/PM hand move along together.

Correctly adjust them to “12:00 AM”.

4 Press Button B and then release it

The watch goes into the preliminary position setting mode of the stopwatch 1/20-second hand.

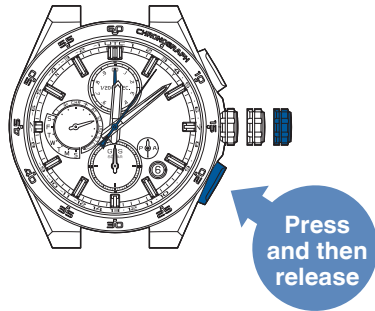

The seconds hand stops at the 6-second position.
The stopwatch 1/20-second hand turns and stops to indicate the preliminary position.

5 Turn the crown to set the stopwatch 1/20-second hand to 0.00 seconds

* When 0.00 seconds is displayed, go to operation **6**.

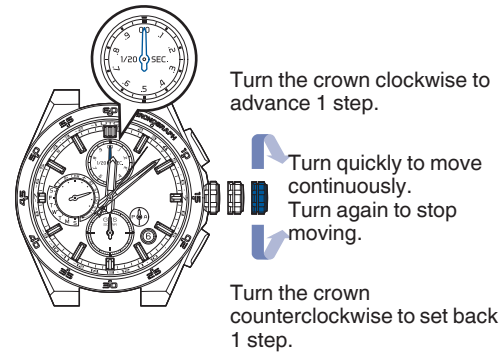

6 Press Button B and then release it

The watch enters the mode to adjust the preliminary position of the multi-function indicator hand.

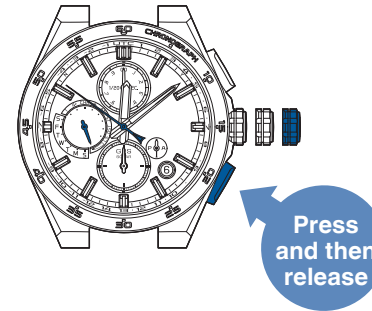

The seconds hand stops at the 51-second position.
The multi-function indicator hand stops to indicate the preliminary position.

7 Turn the crown to adjust the multi-function indicator hand to a charging status display of "low"

* If the hand is indicating a charging status display of "low," go to operation **8**.

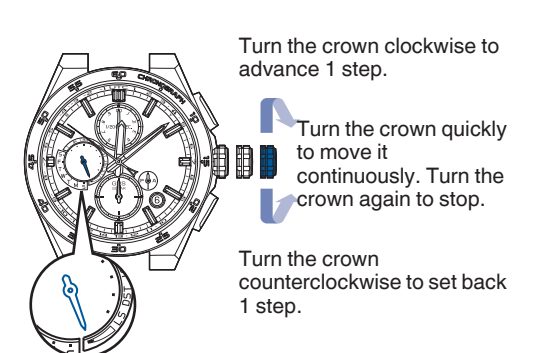

8 Press Button B and then release it

The watch enters the mode for setting the preliminary position of the date.

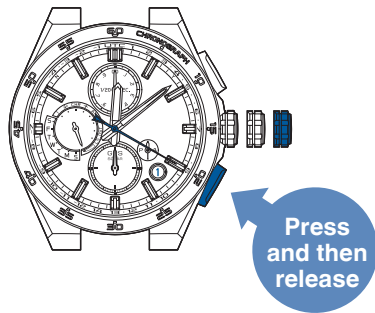

* During movement of the date, the buttons cannot be operated.

The seconds hand stops at the 20-second position.
The date moves, and stops when it indicates the preliminary position.

9 Turn the crown to adjust the date to "1"

Adjust so that the numeral "1" appears in the center of the date window.

* If "1" appears for the date, go to operation **10**

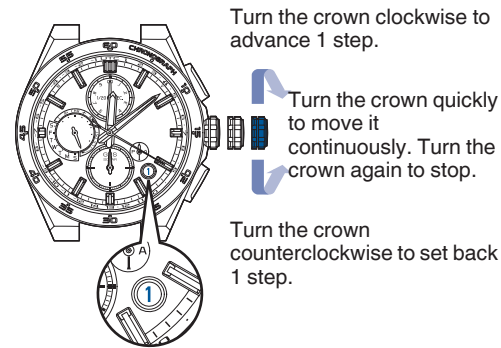

10 Press Button B and then release it

The watch goes into the preliminary position setting mode of the hour and minute hands.

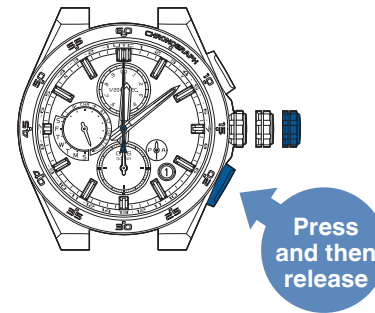

The seconds hand stops at the 0-second position.

11 Continue to press Button A (3 seconds)

The hour/minute hands move, and stop at "12:00 AM".

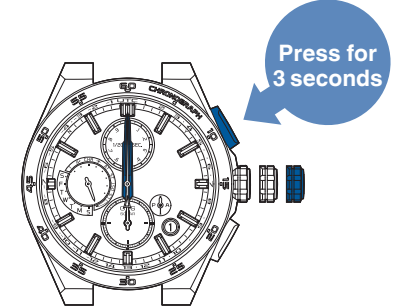

12 Push the crown back in

The watch exits the mode to adjust the preliminary position, and the seconds hand and the hour/minute hands start moving.

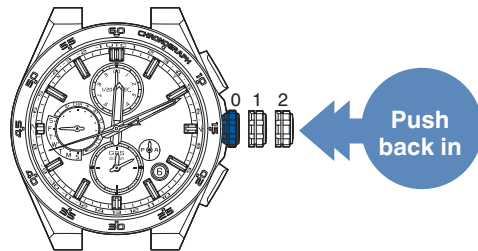
**13 Set the time by receiving GPS signals**

When you are in a place where GPS signals can be easily received, adjust the time zone.

→ How to adjust the time zone [P. 22](#)

When operations **1** to **12** are complete, be sure to set the time.

When you are in a place where GPS signals cannot be received

① Carry out manual time zone setting



→ How to manually set the time zone [P. 25](#)



② Manually set the time

→ How to manually set the time [P. 50](#)



When the time is set, operation is completed.

Troubleshooting

Troubleshooting		Possible causes	Solutions	Reference pages
Hand Movement	The seconds hand moves at 2-second intervals.	The energy depletion forewarning function is activated. (P. 39) If the seconds hand moves at 2 or 5-second intervals while you wear the watch every day, the watch is in a condition where it cannot acquire sufficient light, for instance, the watch is concealed under a long sleeve shirt.	Charge the watch sufficiently until the seconds hand moves at 1-second intervals and the multi-indicator hand returns to the day of the week display from a charging status display of "low." Be careful not to conceal the watch under a sleeve, etc., while wearing it. When taking off the watch, place it in as bright a location as possible.	 middle P. 14 P. 16
	The seconds hand moves at 5-second intervals.			
	The stopped seconds hand pointing to the 15-second position started operating.	The power save function 1 has been activated. (P. 39) When the watch has not been exposed to sufficient light continuously, the power save function 1 to limit energy consumption is automatically activated.	When the watch is exposed to light, the hand will rapidly advance and return to the current time. When the watch returns to the current time, use it as is. (This is not an abnormal movement.)	-
	The stopped seconds hand pointing to the 45-second position started operating.	The power save function 2 has been activated. (P. 39) When the watch is not sufficiently charged for a certain period of time, the power save function 2 is automatically activated.	① Charge the watch sufficiently until the multi-indicator hand returns to the day of the week display from a charging status display of "low." ② After that, when the time is incorrect, adjust the time zone as necessary.	P. 14 P. 16 P. 21 - 22
	The watch hands advance rapidly unless a button is pressed. After the rapid advancement is completed, the watch resumes its normal 1-second interval movement.	The power save function has been activated. (P. 39) The automatic hand position alignment function was activated. When the hand positions deviate to display incorrect time as a result of external influences, etc., the watch automatically corrects the hand misalignment by the automatic hand position alignment function.	No operation is needed (this is not an abnormal movement.)	-
	The indicator hand indicates the "LS"	The automatic leap second reception function is operating. (P. 33) 	It takes up to 18 minutes to receive the leap second data. Pay attention to the reception place "(Place where GPS signals can be easily received)." P. 18	P. 33

Troubleshooting	Possible causes	Solutions	Reference pages
Reception is not started even with operation of time zone adjustment/manual time adjustment.	The charging status display is "low". (P. 12) 	Charge the watch sufficiently until the multi-indicator hand returns to the day of the week display from a charging status display of "low."  middle	P. 14
	The in-flight mode (✈) has been set. (P. 32) 	After relocation from a place under restriction on use of GPS signals (in an airplane, etc.), reset the in-flight mode (✈).	P. 32
GPS signals cannot be received even by carrying out GPS signal reception (The reception result is displayed as "N".)	You are in a place where GPS signals cannot be received. (P. 18)	Receive GPS signals in a place where GPS signals can be easily received.	P. 18
GPS signal reception Reception is possible (reception result display becomes "Y"), but the time and date are not accurate (when it is understood as a reception result after time adjustment).	The time zone that does not correspond to the region where you are has been set.	Check the time zone setting. If the time zone does not correspond to the region where you are, adjust the time zone. <ul style="list-style-type: none"> • When you are in a place where GPS signals can be easily received → How to adjust the time zone P. 22 • When you are in a place where GPS signals cannot be received → How to manually set the time zone P. 25 	P. 27 P. 22 P. 25
	DST (Daylight Saving Time) setting does not correspond to the addition conditions of DST (Daylight Saving Time).	Check DST (Daylight Saving Time) setting. Do the time zone adjustment when you are in a place where it is easy to receive GPS signals. → How to adjust the time zone P. 22	P. 27 P. 22
Reception is possible (reception result display becomes "Y"), but the time and date are not accurate (when it is understood as a reception result after time zone adjustment).	DST (Daylight Saving Time) setting does not correspond to the addition conditions of DST (Daylight Saving Time).	Check DST (Daylight Saving Time) setting. Do the time zone adjustment when you are in a place where it is easy to receive GPS signals. → How to adjust the time zone P. 22	P. 27 P. 22
	The positions of the hands are misaligned due to external influences. The preliminary positions of the hands are incorrect. → Preliminary position P. 51	① <Hour/minute hand misalignment> The automatic hand position adjustment function is activated to automatically adjust the positions. Please use the watch as it is. The automatic hand position alignment function is activated once every 10 minutes for the seconds hand, once an hour for the minute hand, and once every 12 hours for the hour hand. <Date misalignment> Since the preliminary position is not automatically adjusted, manually adjust the position. ② If the hand misalignments are not corrected, refer to "When the sub-dial, stopwatch 1/20-second hand, multi-function indicator hand, date, or hour/minute/seconds hand position is misaligned" and perform the operations. ③ When misalignment of the hand is not adjusted even with operation of ②, consult the retailer from whom the watch was purchased.	P. 51 P. 52
The reception result is displayed as "Y", but the time is gained or lost by one to two seconds.	The automatic time adjustment function has not been activated for a few days.	When energy is insufficient, the automatic time adjustment may operate only once every 3 days.	P. 31

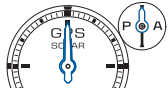
Troubleshooting		Possible causes	Solutions	Reference pages
GPS signal reception	The automatic time adjustment function is not activated every day.	The energy stored in the watch is insufficient. Conditions to activate the automatic time adjustment function are not prepared.	Sufficient energy is necessary to activate the automatic time adjustment function every day. Keep in mind to frequently expose your watch light to charge its battery. The automatic time adjustment is automatically activated by exposure to bright light when you are in a place that easily receives GPS signals.	P. 31
	Automatic reception is not activated.	The watch is not in an environment where GPS signals can be received at the moment when the watch is exposed to light.	While the watch has a function that automatically starts receiving when exposed to light, it also has a function that activates "automatic time adjustment" at the time that "manual time adjustment" was last successful, even in environments that are not exposed to light. Normally, we recommend that, to succeed with manual time adjustment, do it at a specific time, at which you think you will be in an environment that can receive GPS signals. Automatic time adjustment function judges the situation. Thereby the automatic time adjustment function gets activated even in the case where it has not been able to receive light.	P. 24
Misalignment of time and hands	The position of the seconds hand showing "reception result" and "number of acquired satellites from which GPS signals are received" is misaligned.	The preliminary position of the seconds hand is incorrect. (This can occur when the position of the seconds hand is incorrect due to external influences.) → Preliminary position P. 51	① The automatic hand position alignment function is activated to automatically adjust the position. Please use the watch as it is. The automatic hand position alignment function is activated once every 10 minutes for the seconds hand. ② When misalignment of the hand is not adjusted, consult the retailer from whom the watch was purchased.	P. 51
	The watch temporarily gains or loses time.	The automatic time adjustment function has not been activated for a few days.	If the energy stored in the watch is insufficient, the automatic time adjustment function may be activated once in 3 days. To adjust the time immediately, carry out "manual time adjustment."	P. 31 P. 24
		The watch received an incorrect time due to external factors (erroneous reception).	① Receive GPS signals in a place where GPS signals can be more easily received. ② Adjust the time zone as necessary.	P. 18 P. 22
		The watch is left in an extremely high or low temperature place for a long time.	① If the watch is returned to a normal temperature place, the accuracy will be recovered. ② If the time is incorrect after that, manually adjust the time as necessary. ③ If the watch is not recovered, consult the retailer from whom the watch was purchased.	P. 24
	The time is gained (lost) by 1 hour.	DST (Daylight Saving Time) is ON (or OFF).	Check DST (Daylight Saving Time) setting. Do the time zone adjustment when you are in a place where it is easy to receive GPS signals. → How to adjust the time zone P. 22	P. 27 P. 22
Charging the solar battery	The stopped watch was exposed to an adequate light for longer than the time required to fully charge the watch, however, it does not resume its normal 1-second interval movements.	The amount of exposed light is too weak. The time for charging the watch is not sufficient.	The time required for charging the watch depends entirely on the amount of exposed light the watch receives. Refer to "Standard Charging Time" to charge the watch.	P. 16
	The seconds hand is stopped even when the watch is charged for longer than the time required to fully charge the watch.	The watch was not charged for a long time and has been discharged completely.	Contact the retailer from whom the watch was purchased.	-

Troubleshooting		Possible causes	Solutions	Reference pages
Misalignment of date	After the reception is successful, the time is correct but the date is incorrect.	The preliminary position of the date is out of alignment. This problem occurs when the preliminary position of the date is out of alignment due to external influence etc.	Adjust the preliminary position of the date to the correct position "1" (the first day of a month).	P. 52 - 55
Misalignment of day of the week	After the reception is successful, the time is correct but the date is incorrect.	The preliminary position of the multi-function indicator hand is incorrect. This occurs when the preliminary position of the multi-function indicator hand is misaligned due to external factors.	Adjust the preliminary position of the multi-function indicator hand to the correct position of "low" (charging status display).	 P. 52 - 55
The sub-dial cannot be adjusted.	After the reception is successful, the basic time is correct but the time zone selected on the sub-dial is not displayed.	The preliminary position of the sub-dial is out of alignment. This problem occurs when the preliminary position of the sub-dial is out of alignment due to external influence etc.	Correctly adjust the sub-dial and the AM/PM hand to the preliminary position of "12:00 AM".	 P. 52 - 55
Misalignment of multi-function indicator hand	The position of the hand showing the reception way, charging status, in-flight mode (✈), and DST is misaligned	The automatic leap second reception function has been activated, and the indicator hand indicates the "LS"	It takes up to 18 minutes to complete the leap second reception. Use the watch with reference to the P. 18.	P. 33
		 The preliminary position of the multi-function indicator hand is incorrect. This occurs when the preliminary position of the multi-function indicator hand is misaligned due to external factors.		
Misalignment of stopwatch hands	The stopwatch hands do not correctly display the 0-second position after resetting.	The preliminary positions of the stopwatch hands are incorrect.	Correctly set the preliminary positions of the stopwatch hands.	P. 52 - 55
Stopwatch measurement	Rapid advancement of the main-dial (hour, minute, seconds) temporarily stops during stopwatch measurement.	The stopwatch 1/20-second hand is running (maximum of one minute).	Wait without doing anything. When the stopwatch 1/20-second hand stops at the 0-second position, the main-dial will resume rapid advancement.	-

Troubleshooting		Possible causes	Solutions	Reference pages
Operation	The crown or buttons cannot be operated.	The stored electric power is running short.	Sufficiently charge the watch until it starts moving at 1-small second intervals.	P. 16
		Date is moving right after a setting is carried out by the crown or button operation.	Wait without doing anything. After the date stops, the crown and buttons can be operated.	-
	You get lost in the middle of the operation.	-	When the crown is pulled out ① Push the crown back in. ② The seconds hand will start to move within 6 minutes. ③ After that, restart operation.	-
			When the crown is not pulled out ① Press Button B. ② The seconds hand will start to move within 2 minutes. ③ After that, restart operation.	-
Other trouble	Blur in the display persists.	A small amount of water has got inside the watch due to deterioration of the gasket, etc.	Consult the retailer from whom the watch was purchased.	-

Index

Functions to adjust the time

GPS signal reception → [P. 18](#)

Time zone adjustment function..... This watch displays the precise local time, including DST (Daylight Saving Time), through signals received from GPS satellites and by using one press of a button to specify the time zone that you are in.
→ [P. 21](#)

Use this function when you travel to a region corresponding to another time zone.

Manual time adjustment function..... Displays the precise current time of the currently set time zone by receiving GPS signals from GPS satellites.
→ [P. 23](#)

Use this function to adjust the time to the precise time during normal use.

Automatic time adjustment... Judges inside the watch the timing suitable for GPS signal reception from GPS satellites and automatically starts reception.
→ [P. 31](#)

Displays the precise current time of the currently set time zone.

Manual time zone setting..... The time zone of the main-dial can be changed.
→ [P. 25](#)

Also the time of the sub-dial is adjusted by manual time zone selection before use.

DST (Daylight Saving Time) setting..... The DST (Daylight Saving Time) of the main-dial and the sub-dial can be set manually.
→ [P. 26](#)

Functions to charge

Solar Charging Function..... The watch converts light to electrical energy and charges the battery, using the solar cell beneath the dial. The watch will operate for about 6 months on a full charge.
→ [P. 16](#)

Charging status display function..... Roughly displays the energy charged in the watch. Also shows whether the watch is able to receive GPS signals.
→ [P. 14](#)

Power Save Function..... The Power Save mode can be activated in order to reduce unnecessary energy consumption when the watch is left without an adequate light source.
→ [P. 39](#)

Function for reception

In-flight mode (✕) → P. 32	Function to prevent the GPS signal reception function from working. Set this mode when boarding an airplane, etc.
Satellite acquisition status display function → P. 22	Displays by the seconds hand the number of GPS satellite from which GPS signals are received during GPS signal reception.
Reception result display function → P. 20	Displays the latest reception result (success/failure).
Time zone setting check function → P. 27	Displays the currently set time zone.

Other functions

Dual time display function → P. 28	The time of an area different from the time of the main-dial is displayed with the sub-dial at the 6 o'clock position (12-hour) and the AM/PM hand.
Stopwatch function → P. 35	The stopwatch can measure up to 12 hours in 1/20-second increments. A split function is provided.
Automatic hand position alignment function → P. 51	Automatically corrects misalignment when the hands are misaligned due to external factors such as magnetic influence.
Automatic leap second reception function → P. 33	Automatically receives leap second data when leap second data reception is necessary.
Switch function for the main-dial and sub-dial → P. 30	Your watch can switch between the times of its main-dial and sub-dial. It can also switch DST.

SPECIFICATIONS

1. Basic function	Main-dial (hour, minute, and seconds hands), date display, day display, indicator function, dual time display function (with AM/PM hand), world time function (38 time zones), stopwatch (hour, minute, 1/20-second hand)
2. Frequency of crystal oscillator	32,768 Hz (Hz = Hertz ... Cycles per second)
3. Loss/gain (monthly rate)	Loss / gain ± 15 seconds on a monthly rate (When the watch is used without an automatic time setting by receiving GPS signal and when it is worn on the wrist within a normal temperature range between 5°C and 35°C (41°F and 95°F)).
4. Operational temperature range	Between -10°C and +60°C (14°F and 140°F)
5. Driving system	Step motor: main-dial (hour, minute, and seconds hands), multi-function indicator hand, date, sub-dial (hour, minute, and AM/PM hand), stopwatch 1/20-second hand
6. Power source	Secondary battery, 1 piece
7. Duration of operation	About 6 months (on a full charge, without power save function) * If the Power Save is activated after it is fully charged, the watch continues to run for approximately 2 years at maximum.
8. GPS signal reception function	Time zone adjustment, manual time adjustment, automatic time adjustment * Between reception and the next reception, the watch operates with the above quartz precision
9. IC (Integrated Circuit)	Oscillator, frequency divider and driving circuit C-MOSIC, 4 pieces

* The specifications are subject to change without prior notice due to product improvements.

Declaration of Conformity